

Technical Data

LTM 1360N

リープヘル製
オールテレーンクレーン
吊上荷重360ton

メインブーム
60m

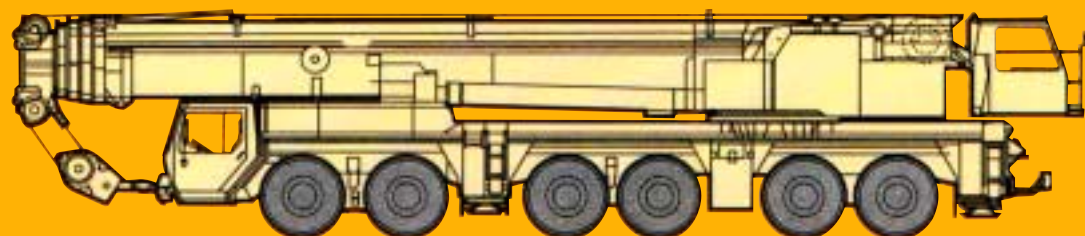

LIEBHERR

クレーン

クレーン部主仕様

吊上荷重	360ton×3.0m	
メインブーム長さ	15～60m	
補助ジブ	固定式	14～42m
	固定式(ガイ仕様)	14～49m
	起伏式	17.5～70m
メインブーム段数	5段	
カウンタウイト	87.5/112.5ton	
第1ウインチ	ラインプル	10.7ton
	巻上速度	0-130m/分
	ワイヤー長さ/径	450m/23mm
第2ウインチ	ラインプル	10.7ton
	巻上速度	0-130m/分
	ワイヤー長さ/径	450m/23mm
第3ウインチ (起伏ジブ用)	ラインプル	10.7ton
	巻上速度	0-130m/分
	ワイヤー長さ/径	640m/23mm
最大地上揚程	メインブーム	59m
	補助ジブ	115m
旋回速度	0-1.5rpm	
起伏速度(82度まで)	約70秒	
ブーム伸縮速度(15～60m)	約380秒	

*ガイ仕様についてはオプション設定です。

フック仕様

容量 (ton)	シーブ数
360	9×2
215	12
176	9
143	7
108	5
71	3
32	1
10.5	—

フックはオプション設定ですので表の中からお選びください。



エンジン仕様

メーカー名	リープヘル社製
型式	D924TI-E ディーゼル
冷却方式	水冷
シリンダー数	4
出力	245HP 1800rpm
最大トルク	107kg-m 1100rpm
燃料タンク	300 ℓ

特徴

コントロール

ジョイスティックタイプの操作レバー(自動復帰式のユニバーサルコントローラ)により電気式パイロットコントロールされます。

油圧駆動装置

ウインチ回路には圧力補償付流量調整弁を有し、また、自動出力調整装置付油圧ポンプにより駆動されます。

安全装置および指示計

LICCON(リーコン) 過負荷防止計が装備され、吊上げ総荷重、作業半径、ブーム長さ、揚程及びアウトリガ反力等がデジタルで表示されます。

過巻防止装置、ドラム回転計、過巻出し防止装置、油圧安全弁、油圧システム保護用安全バルブが装備されています。

キャビンが20度までチルトバックします。

● キャリア

キャリア部主仕様

軸数	6
最高速度	76km/h
総輪数	12
定員	2名
タイヤ	16.00 R25
登坂能力* (低速切換時)	約21.3°
最小回転半径	11.4m

*登坂時の路面状況により、能力も多少異なります。

エンジン仕様

メーカー名	リープヘル社製
型式	D9408TI-E ディーゼル・エンジン
冷却方式	水冷
シリンダー数	8
出力	598HP 1900rpm
最大トルク	265kg-m 1400rpm
燃料タンク	約600 ℓ

走行速度

ギア	1	2	3	4	5	R
① (km/h)	15	24	37	55	76	14
② (km/h) ③	8	14	22	32	44	7.5

特徴

トランスミッション

アリソン製ミッションでトルクコンバーター及びリターダーを内蔵しております。
前進5段、後進1段となっております。

サスペンション

全軸ハイドロニューマチックサスペンションであり、自動水平復帰機能（ニポー）を有しています。
状況に応じて車高を上下に調整可能です。
全軸油圧サスペンションをロックすることが可能です。

ステアリング

油圧源として1つは通常時、エンジンで駆動され、もう1つは非常用として駆動軸により駆動されます。

常用ブレーキ

2回路式サーボブレーキが全軸に装備されています。
また、エディカレント式電磁ブレーキ（オプション）を装備しています。

パーキング用ブレーキ

スプリング作動のブレーキが第2～6軸に作動します。

駆動部

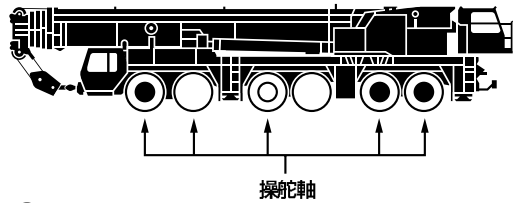

● 駆動軸：常時駆動します。

○：追加駆動軸

第5軸及び6軸の独立リアステアリング操作によりクラブ及びカウンター走行を行うことが可能です。

本機は、公道を走行する場合、メインブームを別送として走行しなければなりません。



メインブーム揚程

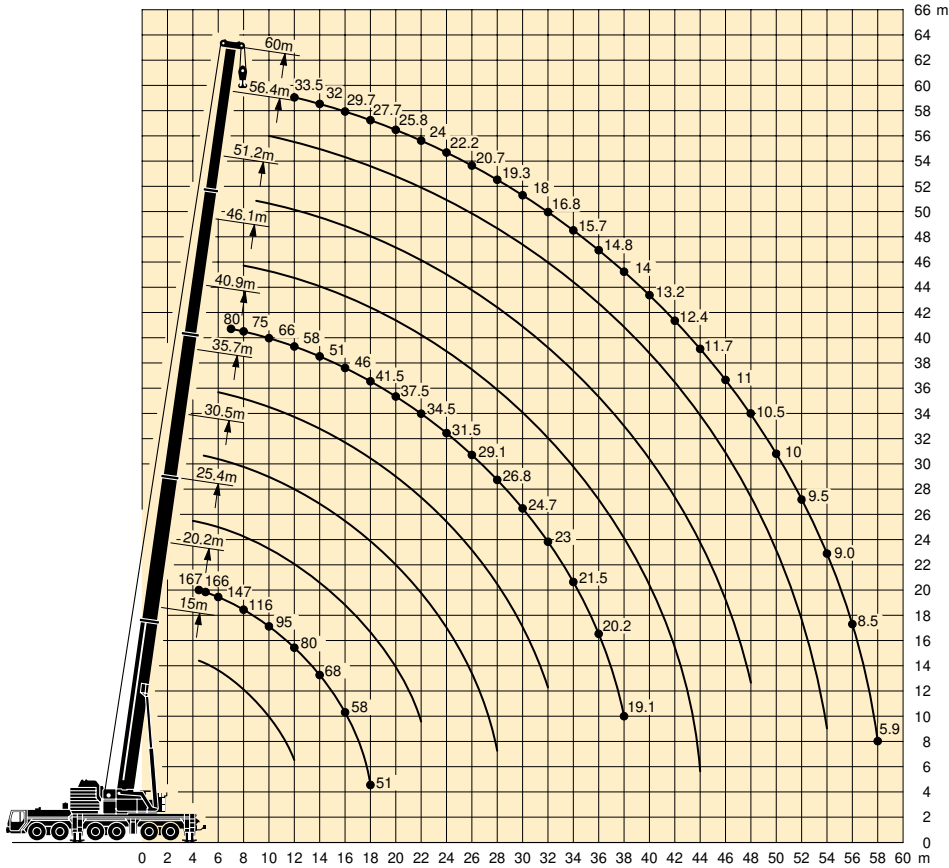

注意

- 1 定格総荷重はフックブロック、玉掛ワイヤー等の自重を含みます。
また、下記の条件が考慮されていないのでクレーンの操作には充分気をつけてください。
① 地盤の強度、地震による影響
② 作業速度に応じた動荷重および台風または強風による影響等
- 2 本機は水平に設置して、クレーン作業を行ってください。
- 3 作業半径は、クレーンの旋回中心から荷重の重心までの水平距離です。
- 4 メインブームの定格総荷重は補助ジブを取り除いた状態での値です。
- 5 152トンを超える定格総荷重の場合は、特殊吊装置が必要です。
- 6 カウンターウエイト 112.5t の場合の値です。

メインブーム揚程(ガイ仕様)

オプション設定

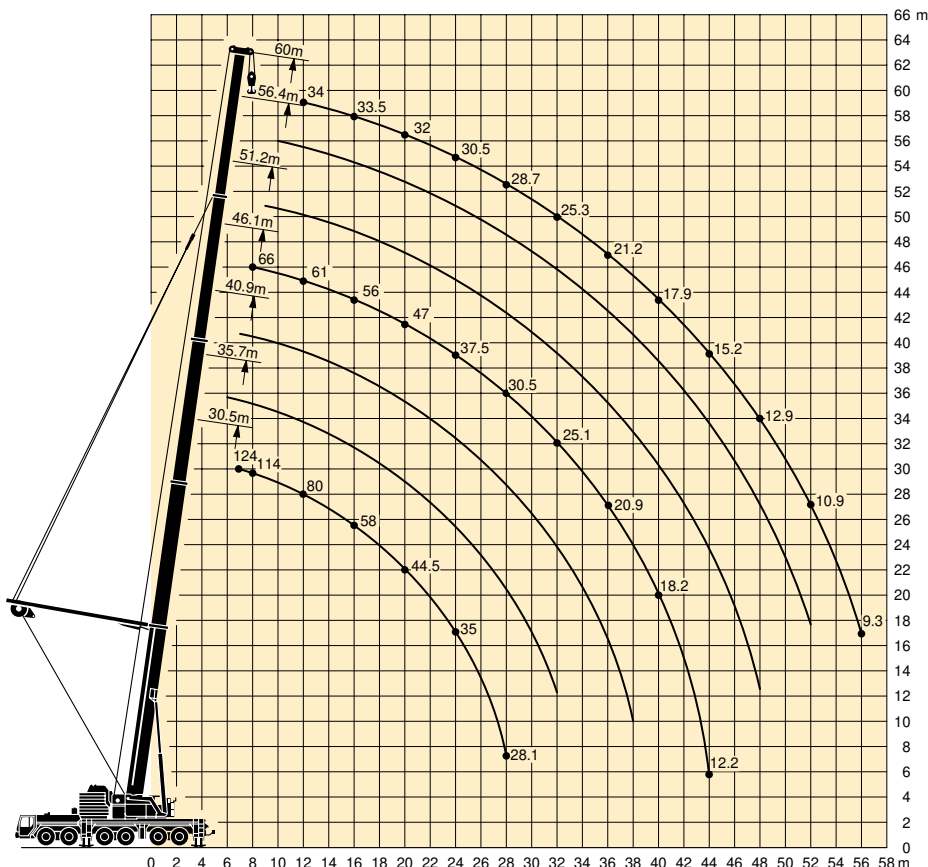

注意

- 1 定格総荷重はフックブロック、玉掛ワイヤー等の自重を含みます。
また、下記の条件が考慮されていないのでクレーンの操作には充分気をつけてください。
① 地盤の強度、地震による影響
② 作業速度に応じた動荷重および台風または強風による影響等
- 2 本機は水平に設置して、クレーン作業を行ってください。
- 3 作業半径は、クレーンの旋回中心から荷重の重心までの水平距離です。
- 4 メインブームの定格総荷重は補助ジブを取り除いた状態での値です。
- 5 152トンを超える定格総荷重の場合は、特殊吊装置が必要です。
- 6 カウンターウエイト 112.5t の場合の値です。

● メインブーム定格総荷重表

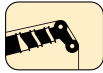

15m-60m

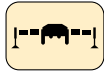

8.85m x 8.5m



360°

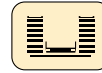

112.5t

メインブーム 長さ 作業半径(m)	15m	20.2m	25.4m	30.5m	35.7m	40.9m	46.1m	51.2m	56.4m	60m
4			167							
4.5	178	167	167							
5	166	166	156	133						
6	147	147	140	122	99					
7	130	130	126	111	91	80				
8	116	116	114	102	84	75	64			
9	105	105	104	93	78	70	60	51		
10	95	95	94	86	73	66	57	48.5		
12	80	80	79	74	64	58	51	44.5	41	33.5
14		68	67	65	57	51	45.5	40.5	35	32
16		58	58	57	51	46	41	36.5	32.5	29.7
18		51	50	51	46.5	41.5	37	33.5	29.9	27.7
20			44.5	45	42	37.5	33.5	30.5	27.7	25.8
22			39.5	40.5	38.5	34.5	30.5	27.8	25.8	24
24				36.5	35.5	31.5	28.1	25.7	23.9	22.2
26				33	32.5	29.1	25.8	23.8	22.2	20.7
28				29.9	30.5	26.8	24	22	20.6	19.3
30					28.2	24.7	22.4	20.3	19.2	18
32					25.9	23	20.8	19	17.8	16.8
34						21.5	19.3	17.8	16.7	15.7
36						20.2	18.2	16.6	15.7	14.8
38						19.1	17	15.5	14.8	14
40							16	14.7	13.9	13.2
42							15.2	14	13	12.4
44							13	13.1	12.4	11.7
46								12.4	11.8	11
48								11.7	11.3	10.5
50									10.7	10
52									10.1	9.5
54									9.5	9
56										8.5
58										5.9
ブーム 伸長率 (%)	I 0	0/0	46/0/0	92/46/0/0	92/46/0/0	92/46/0	92/46/0	92/46	92	100
	II 0	46/0	46/0/0	46/46/46/0	46/46/92/0	46/92/92	92/92/92	92/92	92	100
	III 0	0/0	0/46/0	0/46/46/92	46/46/46/92	46/46/92	46/92/92	92/92	92	100
	IV 0	0/46	0/46/92	0/0/46/46	0/46/46/92	46/46/46	46/46/92	46/92	92	100

TAB 122362



15m-60m

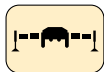

8.85m x 8.5m



360°



87.5t

メインブーム 長さ 作業半径(m)	* 15m	20.2m	25.4m	30.5m	35.7m	40.9m	46.1m	51.2m	56.4m	60m
3	360	220								
3.5	221	203	167							
4	206	188	167	167						
4.5	191	175	167	167						
5	177	163	162	156	133					
6	152	142	142	140	122	99				
7	130	125	125	124	111	91	80			
8	114	112	112	111	102	84	75	64		
9	101	101	100	100	93	78	70	60	51	
10	90	90	90	90	86	73	66	57	48.5	41
12	74	74	74	73	74	64	58	51	44.5	37.5
14			62	62	63	57	51	45.5	40.5	35
16			54	53	54	51	46	41	36.5	32.5
18			47.5	46	47	46.5	41.5	37	33.5	29.9
20				40.5	41.5	42	37.5	33.5	30.5	27.7
22				36	36.5	38	34.5	30.5	27.8	25.8
24					32.5	33.5	31.5	28.1	25.7	23.9
26					30.5	30.5	29.1	25.8	23.8	22.2
28					28.2	27.3	26.3	24	22	20.6
30						24.8	24	22.4	20.3	19.2
32						22.6	22.5	20.8	19	17.8
34							20.5	19.3	17.8	16.7
36							18.8	17.9	16.6	15.7
38							17.4	16.9	15.5	14.8
40								16	14.7	13.9
42								15	14	13
44								13	13	12.4
46									12.4	11.8
48									11.7	11.3
50										10.7
52										9.9
54										9.2
56										8.4
58										5.9
ブーム 伸長率 (%)	I 0	0/0	46/0/0	92/46/0/0	92/46/0/0	92/46/0	92/46/0	92/46	92	100
	II 0	46/0	46/0/0	46/46/46/0	46/46/92/0	46/92/92	92/92/92	92/92	92	100
	III 0	0/0	0/46/0	0/46/46/92	46/46/46/92	46/46/92	46/92/92	92/92	92	100
	IV 0	0/46	0/46/92	0/0/46/46	0/46/46/92	46/46/46	46/46/92	46/92	92	100

*後方吊り

TAB 122515.122364

LTM 1360N

Technical Data

メインブーム定格総荷重表



15m-60m



8.85m x 8.5m



360°



50t

メインブーム長さ 作業半径(m)	15m	20.2m	25.4m	30.5m	35.7m	40.9m	46.1m	51.2m	56.4m	60m	
3	194										
3.5	178	152									
4	163	152	152								
4.5	150	150	149								
5	139	139	138	121							
6	121	120	120	111	90						
7	104	104	103	101	83	73					
8	90	91	90	91	77	68	58				
9	80	80	79	80	71	63	55	46.5			
10	71	71	71	72	67	60	52	44.5	37		
12	58	58	58	59	58	53	46.5	40.5	34	30.5	
14		49.5	47.5	48	49.5	46.5	41	37	31.5	29	
16		42.5	39.5	42	41.5	40.5	37	33.5	29.4	27	
18		36.5	36	36.5	35.5	35.5	33.5	30.5	27.2	25.2	
20			31.5	31.5	30.5	30.5	29	27.7	25.2	23.5	
22			27.3	27.1	26.9	26.4	25.7	25.2	23.4	21.8	
24				23.6	23.4	22.8	23.4	22.2	21.7	20.2	
26				20.8	20.5	20.2	20.5	19.7	20	18.8	
28				18.8	18.2	18.5	18.1	18.4	18	17.5	
30					16.2	16.5	16.1	16.7	16.1	16	
32					14.5	14.8	14.8	15	14.3	14.4	
34						13.3	13.8	13.5	12.8	13	
36						12	12.6	12.2	11.5	11.6	
38						10.9	11.5	11	10.3	10.4	
40							10.4	10	9.2	9.3	
42							9.5	9	8.2	8.3	
44							8.7	8.2	7.4	7.5	
46								7.4	6.6	6.7	
48								6.7	5.9	6	
50									5.3	5.3	
52									4.7	4.8	
54									4.2	4.2	
56										3.7	
58										3.3	
ブーム 伸長率 (%)	I	0	0/0	46/0/0	46/0/0	92/46/0	92/46/0	92/46/0	92/46	92	100
	II	0	46/0	46/0/0	46/46/0	46/46/92	46/92/92	92/92/92	92/92	92	100
	III	0	0/0	0/46/0	46/46/92	46/46/46	46/46/92	46/92/92	92/92	92	100
	IV	0	0/46	0/46/92	0/46/46	0/46/46	46/46/46	46/46/92	46/92	92	100

TAB 122031



15m-60m

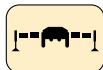

8.85m x 8.5m



360°



37.5t

メインブーム長さ 作業半径(m)	15m	20.2m	25.4m	30.5m	35.7m	40.9m	46.1m	51.2m	56.4m	60m	
3	191										
3.5	174	152									
4	159	152	152								
4.5	147	147	146								
5	136	136	135	121							
6	115	116	115	111	90						
7	99	99	98	99	83	73					
8	86	86	86	86	77	68	58				
9	76	76	75	76	71	63	55	46.5			
10	68	68	67	68	66	60	52	44.5	37		
12	54	54	53	53	53	49	46.5	40.5	34	30.5	
14		46	43	46	43	41.5	39	37	31.5	29	
16		37	38	38	36.5	34.5	33.5	32	29.4	27	
18		30.5	31.5	31.5	31	29.4	29.1	27.2	27.2	25.2	
20			26.5	26.3	26.2	26.1	25.2	24.8	23.6	23.3	
22			23	23	22.3	22.8	22	22.1	20.6	20.4	
24				19.9	19.3	19.7	19.8	19.5	18.1	17.9	
26				17.4	16.8	17.2	17.8	17.4	16	15.8	
28				15.4	15.8	15.1	15.7	15.3	14.2	14.1	
30					14.4	13.4	14	13.6	12.6	12.5	
32					12.9	11.9	12.5	12.1	11.2	11.1	
34						10.5	11.2	10.7	10	9.9	
36						9.3	10	9.5	8.8	8.9	
38						8.3	8.9	8.5	7.7	7.8	
40							8	7.5	6.8	6.9	
42							7.2	6.7	5.9	6	
44							6.5	6	5.2	5.2	
46								5.3	4.5	4.6	
48								4.7	3.9	4	
50									3.4	3.4	
52									2.9	2.9	
54									2.5	2.5	
56										2.1	
58										1.7	
ブーム 伸長率 (%)	I	0	0/0	46/0/0	92/46/0/0	92/46/0/0	92/46/0	92/46/0	92/46	92	100
	II	0	46/0	46/0/0	46/46/46/0	46/46/92/0	46/92/92	92/92/92	92/92	92	100
	III	0	0/0	0/46/0	0/46/46/92	46/46/46/92	46/46/92	46/92/92	92/92	92	100
	IV	0	0/46	0/46/92	0/0/46/46	0/46/46/92	46/46/46	46/46/92	46/92	92	100

TAB 122007.1/2/3/4

● メインブーム定格総荷重表(ガイ仕様) オプション設定

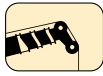

30.5m-60m

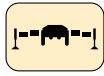

8.85m x 8.5m



360°

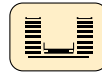

112.5t

メインブーム 長さ 作業半径(m)	30.5m	35.7m	40.9m	46.1m	51.2m	56.4m	60m	
7	124	102	84					
8	114	99	82	66				
9	105	97	80	64	52			
10	95	94	78	63	51	42		
12	80	79	74	61	49.5	41	34	
14	68	69	69	58	48	40	34	
16	58	60	60	56	46.5	39	33.5	
18	51	52	52	53	44.5	37.5	33	
20	44.5	46	46	47	43	36.5	32	
22	39.5	40.5	41	41.5	41	35.5	31	
24	35	36.5	37	37.5	37	34.5	30.5	
26	31.5	32.5	33	33.5	34.5	33.5	29.5	
28	28.1	29.5	29.7	30.5	31.5	30.5	28.7	
30		26.7	26.9	27.5	28.5	27.8	27.8	
32		25.1	24.4	25.1	26	25.3	25.3	
34			22.3	22.9	23.8	23.1	23.1	
36			20.3	20.9	21.9	21.2	21.2	
38			18.6	19.2	20.1	19.4	19.5	
40				18.2	18.6	17.8	17.9	
42				17.4	17.1	16.4	16.5	
44				12.2	15.8	15.1	15.2	
46					14.6	13.9	14	
48					13.5	12.8	12.9	
50						11.8	11.9	
52						10.9	10.9	
54							10.1	
56							9.3	
ブーム 伸長率 (%)	I	46	92/46/ 0	92/46	92/46/ 0	92/46	92	100
	II	46	46/46/ 0	46/92	92/92/92	92/92	92	100
	III	46	46/46/92	46/46	46/92/92	92/92	92	100
	IV	0	0/46/92	46/46	46/46/92	46/92	92	100

TAB 122365

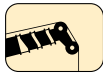

30.5m-60m

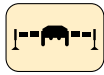

8.85m x 8.5m

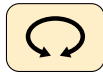

360°

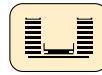

87.5t

メインブーム 長さ 作業半径(m)	30.5m	35.7m	40.9m	46.1m	51.2m	56.4m	60m	
5	138							
6	133	105						
7	124	102	84					
8	112	99	82	66				
9	101	97	80	64	52			
10	91	91	78	63	51	42		
12	75	76	74	61	49.5	41	34	
14	63	64	65	58	48	40	34	
16	54	55	55	55	46.5	39	33.5	
18	46.5	48	48	49	44.5	37.5	33	
20	40.5	42	42.5	43	42.5	36.5	32	
22	35.5	37	37.5	38	39	35.5	31	
24	31.5	33	33	33.5	34.5	34	30.5	
26	27.7	29.2	29.4	30	31	30.5	29.5	
28	24.6	26.2	26.3	27	27.9	27.2	27.2	
30		25.6	23.6	24.3	25.3	24.5	24.5	
32		23.2	21.3	21.9	22.9	22.1	22.2	
34			19.2	19.9	20.8	20.1	20.1	
36			17.4	18.7	19	18.3	18.3	
38			15.8	17.6	17.4	16.6	16.7	
40				16.2	15.9	15.1	15.2	
42				14.8	14.6	13.8	13.9	
44				12.2	13.3	12.6	12.7	
46					12.2	11.5	11.5	
48					11.2	10.5	10.5	
50						9.6	9.6	
52						8.7	8.8	
54							8	
56							7.2	
ブーム 伸長率 (%)	I	46	92/46/ 0	92/46	92/46/ 0	92/46	92	100
	II	46	46/46/ 0	46/92	92/92/92	92/92	92	100
	III	46	46/46/92	46/46	46/92/92	92/92	92	100
	IV	0	0/46/92	46/46	46/46/92	46/92	92	100

TAB 122353

LTM 1360N

Technical Data

固定式ジブ揚程

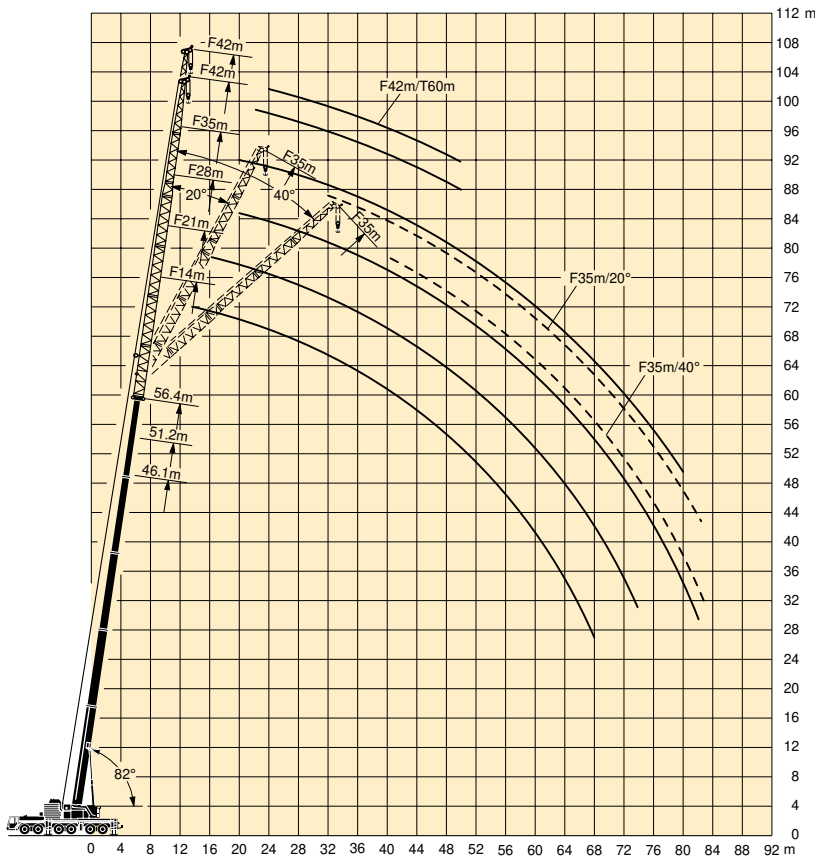

注意

- 1 定格総荷重はフックブロック、玉掛ワイヤー等の自重を含みます。
また、下記の条件が考慮されていないのでクレーンの操作には充分気をつけてください。
① 地盤の強度、地震による影響
② 作業速度に応じた動荷重および台風または強風による影響等
- 2 本機は水平に設置して、クレーン作業を行ってください。
- 3 作業半径は、クレーンの旋回中心から荷重の重心までの水平距離です。
- 4 メインブームの定格総荷重は補助ジブを取り除いた状態での値です。
- 5 152トンを超える定格総荷重の場合は、特殊吊装置が必要です。

固定式ジブ揚程 (ガイ仕様)

オプション設定

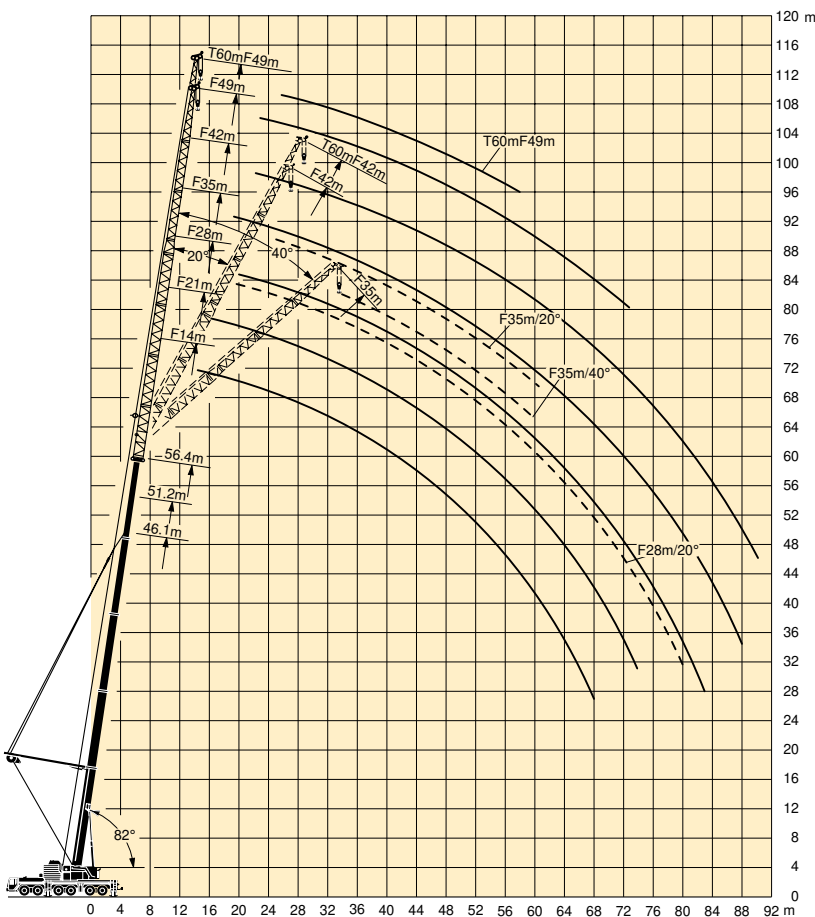

注意

- 1 定格総荷重はフックブロック、玉掛ワイヤー等の自重を含みます。
また、下記の条件が考慮されていないのでクレーンの操作には充分気をつけてください。
① 地盤の強度、地震による影響
② 作業速度に応じた動荷重および台風または強風による影響等
- 2 本機は水平に設置して、クレーン作業を行ってください。
- 3 作業半径は、クレーンの旋回中心から荷重の重心までの水平距離です。
- 4 メインブームの定格総荷重は補助ジブを取り除いた状態での値です。
- 5 152トンを超える定格総荷重の場合は、特殊吊装置が必要です。

● 固定式ジブ定格総荷重表



46.1m-60m



0°
14m-42m

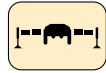

8.85m×8.5m



360°

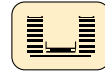

87.5t

メインブーム長さ ジブ長さ	46.1m+2.5m*		51.2m+2.5m*		56.4m+2.5m*				60m+2.5m*
	14m	14m	14m	21m	28m	35m	42m	42m	
12	28.2								
14	26.5								
16	24.8	23.1	17.8						
18	23.3	21.9	16.9	13.1					
20	21.8	20.6	16	12.3	9.9				
22	20.4	19.4	15.2	11.7	9.3				
24	19.1	18.2	14.2	11.1	8.8	7.4			
26	18.1	17	13.4	10.4	8.3	6.5	5.4		4.4
28	17.1	16	12.6	9.8	7.8	6	4.6		4.3
30	16.2	15	11.9	9.2	7.3	5.6	4.2		4
32	15.2	14.2	11.3	8.6	6.8	5.2	3.9		3.7
34	14	13.3	10.7	8.2	6.4	4.9	3.6		3.5
36	13.1	12.5	10.1	7.7	6.0	4.5	3.3		3.3
38	12.3	11.7	9.6	7.3	5.6	4.2	3.0		3.1
40	11.4	11	9.1	6.9	5.3	3.9	2.8		2.9
42	10.7	10.2	8.6	6.5	5.0	3.7	2.6		2.8
44	9.9	9.6	8.2	6.2	4.7	3.5	2.5		2.6
46	9.2	8.9	7.8	5.9	4.5	3.3	2.4		2.4
48	8.7	8.3	7.4	5.6	4.2	3.2	2.3		2.3
50	8.2	7.7	7	5.3	4	3	2.2		2.2
52	7.7	7.1	6.5	5.1	3.8	2.8	2.1		2.1
54	7.2	6.6	6	4.8	3.7	2.7			
56	6.5	6.2	5.5	4.6	3.5	2.6			
58	5.8	5.8	5.1	4.4	3.4	2.4			
60		5.4	4.7	4.2	3.2	2.3			
62		5	4.3	3.9	3.1	2.2			
64		4.5	4.1	3.6	3.1	2.1			
66			3.8	3.3	2.9	2			
68			3.6	3.1	2.8	1.9			
70			3.4	2.9	2.6	1.8			
72				2.7	2.4	1.7			
74				2.5	2.3	1.6			
76				2.3	2.1	1.6			
78					1.9	1.5			
80					1.8	1.4			
82					1.6	1.2			
					1.5				
ブーム伸長率 (%)	I 92	92	92	92	92	92	92	100	
	II 92	92	92	92	92	92	92	100	
	III 46	92	92	92	92	92	92	100	
	IV 46	46	92	92	92	92	92	100	

*アダプター

TAB 122372

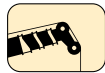

46.1m-56.4m



20°/40°
14m-35m

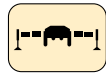

8.85m×8.5m

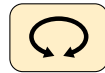

360°

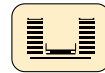

87.5t

メインブーム長さ ジブ長さ	46.1m+2.5m*		51.2m+2.5m*		56.4m+2.5m*							
	14m		14m		14m		21m		28m		35m	
角度	20°	40°	20°	40°	20°	40°	20°	40°	20°	40°	20°	40°
18	19		18.3									
20	18		17.3		12.6							
22	17	12.4	16.3	11.9	11.9							
24	16.2	11.6	15.3	11.6	11.3	10.1						
26	15.4	11.5	14.5	11.4	10.7	9.7	8.5					
28	14.7	11.2	13.7	11.2	10.2	9.3	8					
30	14.1	11	13	10.9	9.8	8.9	7.2	6.3	5.8			
32	13.5	10.8	12.3	10.7	9.3	8.6	6.8	6.1	5.2			
34	13	10.7	11.7	10.6	8.9	8.2	6.5	5.8	4.9			
36	12.4	10.5	11.1	10.5	8.5	8	6.2	5.6	4.6	4		3.8
38	12	10.4	10.6	10.3	8.2	7.7	5.9	5.4	4.4	3.9		3.4
40	11.6	10.2	10.2	9.9	7.9	7.4	5.6	5.2	4.2	3.8		3.2
42	10.9	10.2	9.7	9.5	7.6	7.2	5.4	5	4.2	3.7		3.1
44	10.2	10.2	9.1	9.2	7.3	7	5.2	4.8	3.8	3.6		2.9
46	9.5	9.7	8.5	8.7	7	6.8	5	4.6	3.6	3.5		2.8
48	8.9	9.1	7.9	8.1	6.7	6.6	4.7	4.5	3.5	3.4		2.7
50	8.4	8.5	7.3	7.6	6.4	6.3	4.5	4.3	3.4	3.3		2.6
52	7.9	7.9	6.8	7	6.2	6.1	4.4	4.2	3.3	3.1		2.5
54	7.4		6.4	6.5	6.0	5.9	4.3	4.1	3.3	3.1		2.4
56	6.8	7.4	5.9	6	5.6	5.6	4.1	4	3.1	3		2.3
58		6	5.5	5.6	5.3	5.3	4	3.9	3.0	2.9		2.2
60			5.1	5.6	4.9	5.1	4	3.9	2.9	2.8		2.1
62				5.6	4.6	4.7	3.9	3.9	2.8	2.7		2
64			4.7		4.3	4.4	3.7	3.8	2.7	2.6		1.9
66					4		3.6	3.7	2.6	2.6		1.8
68					3.7		3.3	3.5	2.6	2.6		1.7
70					3.4		3.1	3.2	2.5	2.5		1.6
72							2.9	3	2.4	2.5		1.6
74							2.7		2.4	2.4		1.5
76							2.5		2.3	2.4		1.5
78									2.1	2.1		1.4
80									1.9			1.4
82									1.7			1.4
									1.5			1.3
ブーム伸長率 (%)	I 92		92		92		92		92		92	
	II 92		92		92		92		92		92	
	III 46		92		92		92		92		92	
	IV 46		46		92		92		92		92	

*アダプター

TAB 122373/122374

LTM 1360N

Technical Data

固定式ジブ定格総荷重表(ガイ仕様)

オプション設定



46.1m-60m



0°
14m-49m

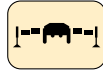

8.85m x 8.5m



360°

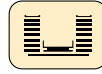

112.5t

メインブーム長さ ジブ長さ	46.1m+2.5m*		51.2m+2.5m*		56.4m+2.5m*						60m+2.5m*	
	14m	14m	14m	21m	28m	35m	42m	49m	42m	49m		
12	31											
14	31											
16	29.7	25	18.7									
18	28.3	24.7	18.5	14.9								
20	27.1	23.7	18.2	14.6	11.3							
22	25.9	23.2	17.8	14.3	11.2							
24	24.8	22.6	17.4	13.8	11							
26	23.8	22	17.1	13.4	10.7							
28	22.8	21.4	16.6	12.9	10.3							
30	21.8	20.8	16.1	12.5	9.9					4.4		
32	20.9	20.2	15.2	11.6	9.3					4.4		
34	20.1	19.7	14.8	11.2	8.9					4.3		
36	19.4	19.1	14.3	10.8	8.7					4.3		
38	17.7	17.7	13.9	10.4	8.4					4.3		
40	16.1	16.2	13.5	10.1	8.1					3.9		
42	14.7	14.7	13.2	9.8	7.8					3.8		
44	13.4	13.4	12.8	9.5	7.5					3.6		
46	12.2	12.2	12.5	9.2	7.3					3.4		
48	11.1	11.2	11.6	8.9	7					3.3		
50	10.1	10.1	10.5	8.6	6.8					3.2		
52	9.1	9.2	9.6	8.3	6.4					3.1		
54	8.3	8.3	8.7	8	6.2					3		
56	7.4	7.4	7.9	7.7	6					2.9		
58	6.6	6.6	7.1	7	5.8					2.8		
60		6.3	6.8	6.6	5.6					2.7		
62			6.4	6.2	5.4					2.6		
64			6.4	6.1	5.2					2.5		
66			6.4	6	5					2.4		
68			6.4	5.9	4.9					2.3		
70			6.4	5.8	4.8					2.2		
72			6.4	5.7	4.7					2.1		
74			6.4	5.6	4.6					2		
76			6.4	5.5	4.5					1.9		
78			6.4	5.4	4.4					1.8		
80			6.4	5.3	4.3					1.7		
82			6.4	5.2	4.2					1.6		
84			6.4	5.1	4.1					1.5		
86			6.4	5	4					1.4		
88			6.4	4.9	3.9					1.3		
90			6.4	4.8	3.8					1.2		
ブーム伸長率(%)	I 92	92	92	92	92	92	92	92	92	100	100	
	II 92	92	92	92	92	92	92	92	92	100	100	
	III 46	46	46	46	46	46	46	46	46	100	100	
	IV 46	46	46	46	46	46	46	46	46	100	100	

*アダプター

TAB 122375



46.1m-56.4m



20°/40°
14m-42m

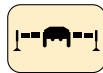

8.85m x 8.5m

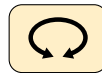

360°



112.5t

メインブーム長さ ジブ長さ	46.1m+2.5m*		51.2m+2.5m*		56.4m+2.5m*									
	角度		14m		14m		21m		28m		35m		42m	
作業半径(m)	20°	40°	20°	40°	20°	40°	20°	40°	20°	40°	20°	40°	20°	
18	21.2		20.5											
20	20.4		19.9		16.5									
22	19.7	12.7	19.3		15.9									
24	18.9	12.4	18.7	12.3	15.4									
26	18.2	12	18.2	12	14.9	11.9								
28	17.6	11.7	17.6	11.7	14.4	11.6	11							
30	17	11.5	17.1	11.5	13.9	11.4	10.6							
32	16.5	11.2	16.6	11.2	13.5	11.1	10.2							
34	16	11	16.1	11	13.1	10.9	9.9	6.9						
36	15.5	10.8	15.7	10.8	12.8	10.8	9.5	6.7	7.9					
38	15.2	10.7	15.3	10.7	12.4	10.6	9.2	6.6	7.6					
40	14.8	10.5	15	10.5	12.1	10.5	8.9	6.4	7.4					
42	14.5	10.3	14.6	10.4	11.8	10.4	8.6	6.3	7.1	4.1				
44	14.1	10.3	14.3	10.2	11.5	10.3	8.4	6.2	6.9	4	5			
46	12.9	10.2	13	10.2	11.3	10.2	8.1	6.1	6.7	4	4.6			
48	11.8	10.2	11.9	10.2	11	10.1	7.9	6	6.5	4	4.3			
50	10.7	10.1	10.8	10.1	10.9	10	7.7	5.9	6.3	4	4.1			
52	9.7	10.1	9.8	10.1	10.6	9.9	7.5	5.8	6	4	4			
54	8.7	9.9	8.8	9.9	10.1	9.7	7.1	5.6	5.7	4	3.9			
56	7.8	8.8	8	9.1	9.9	9.4	6.9	5.5	5.6	4	3.8			
58	6.9		7.1	8.2	9.6	8.8	6.7	5.4	5.5	4	3.7			
60			6.3	7.2	9.4	8.6	6.6	5.3	5.4	4	3.6			
62			5.5		9.2	8.4	6.5	5.3	5.4	4	3.5			
64					9	8.2	6.4	5.2	5.3	4	3.4			
66					8.8	8	6.3	5.1	5.2	4	3.3			
68					8.6	7.8	6.2	5	5.1	4	3.2			
70					8.4	7.6	6.1	4.9	5	4	3.1			
72					8.2	7.4	6	4.8	4.9	4	3			
74					8	7.2	5.9	4.7	4.8	4	2.9			
76					7.8	7	5.8	4.6	4.7	4	2.8			
78					7.6	6.8	5.7	4.5	4.6	4	2.7			
80					7.4	6.6	5.6	4.4	4.5	4	2.6			
82					7.2	6.4	5.5	4.3	4.4	4	2.5			
84					7	6.2	5.4	4.2	4.3	4	2.4			
86					6.8	6	5.3	4.1	4.2	4	2.3			
88					6.6	5.8	5.2	4	4.1	4	2.2			
90					6.4	5.6	5.1	3.9	4	4	2.1			
92					6.2	5.4	5	3.8	3.9	4	2			
ブーム伸長率(%)	I 92		92		92		92		92		92			
	II 92		92		92		92		92		92			
	III 46		46		46		46		46		46			
	IV 46		46		46		46		46		46			

*アダプター

TAB 122376/122377

● 寸法図、走行軌跡図

寸法、重量

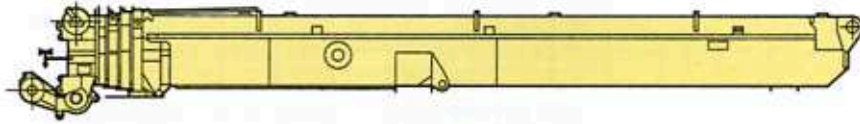

メインブーム
重量25トン
(起伏シリンダ含む)

カウンターウエイト

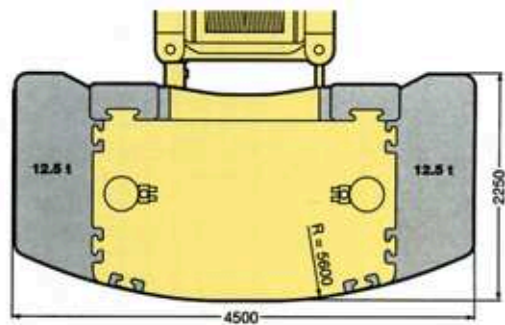
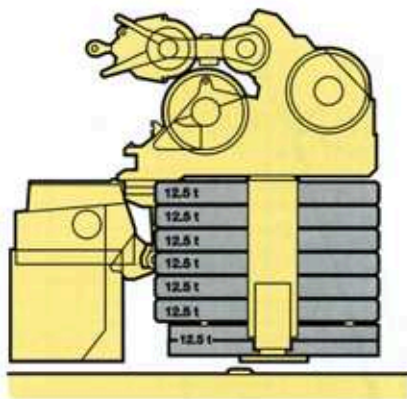

走行軌跡図

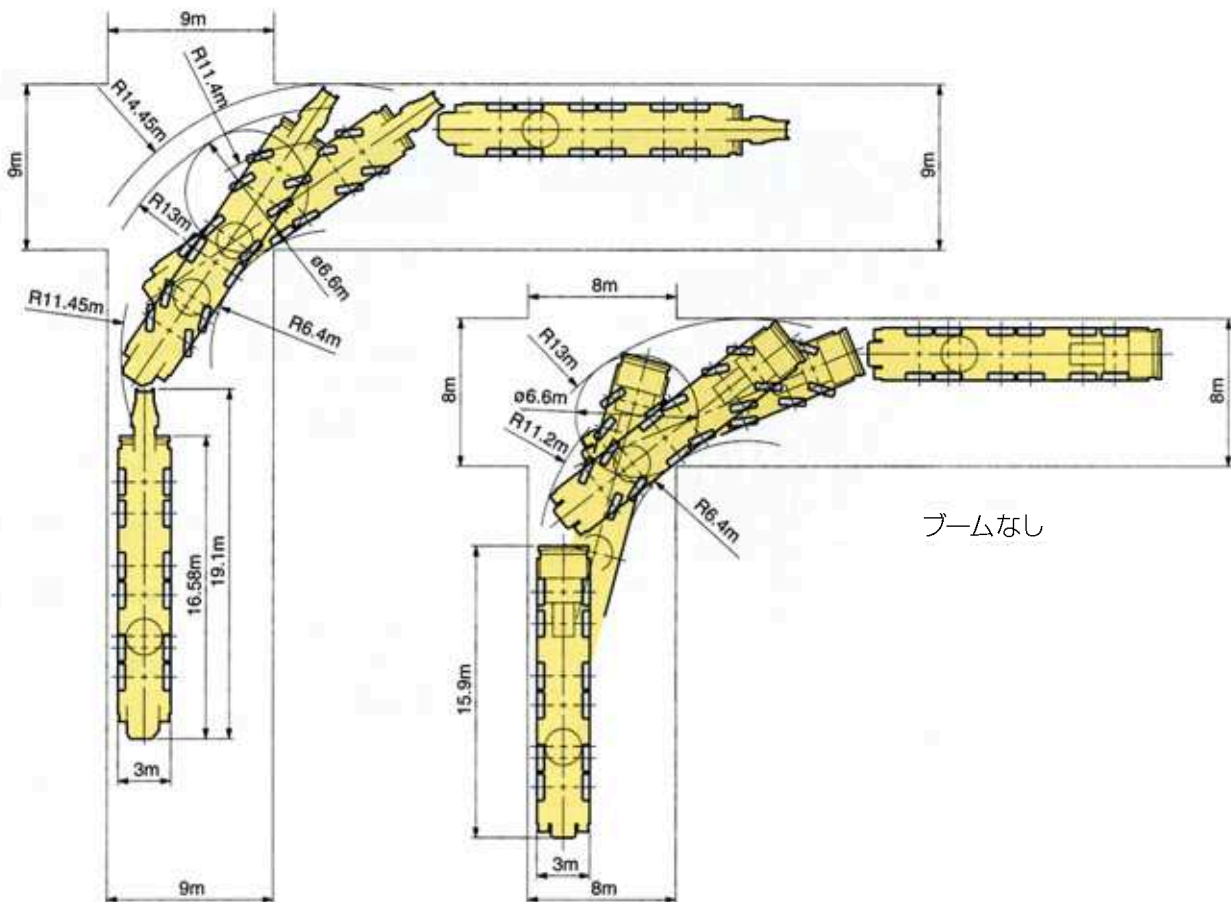

起伏式ジブ揚程

メインブーム82°

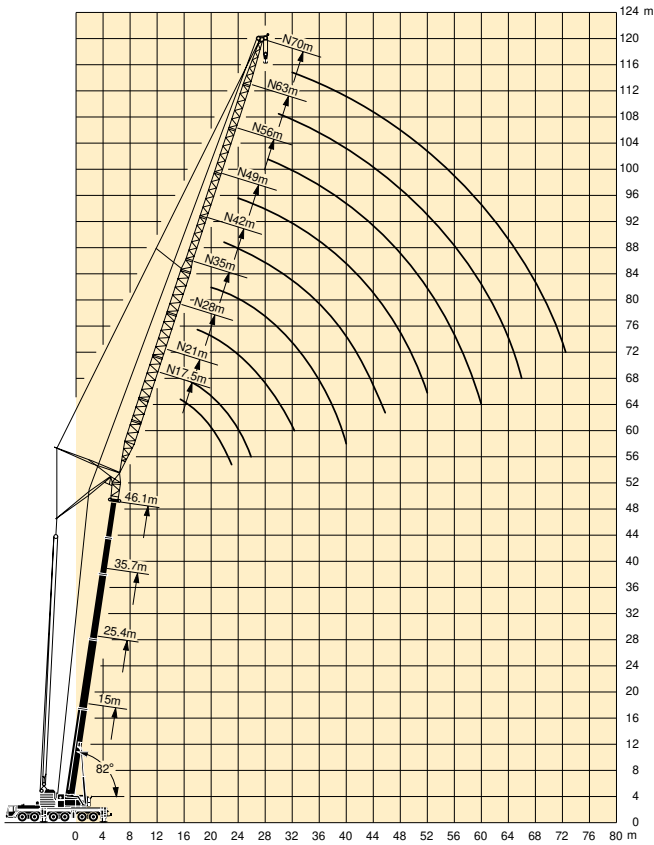

メインブーム74°

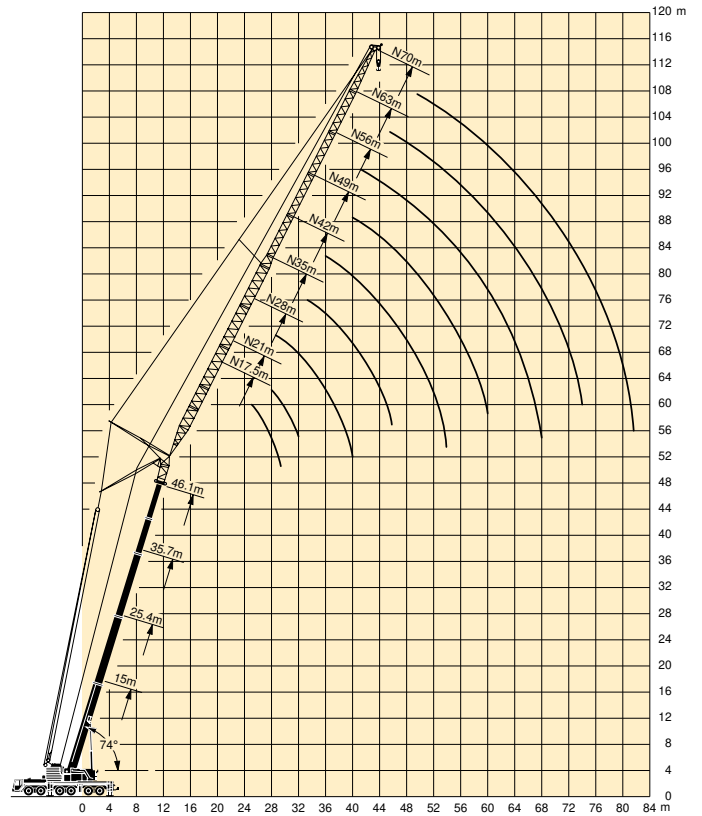

メインブーム66°

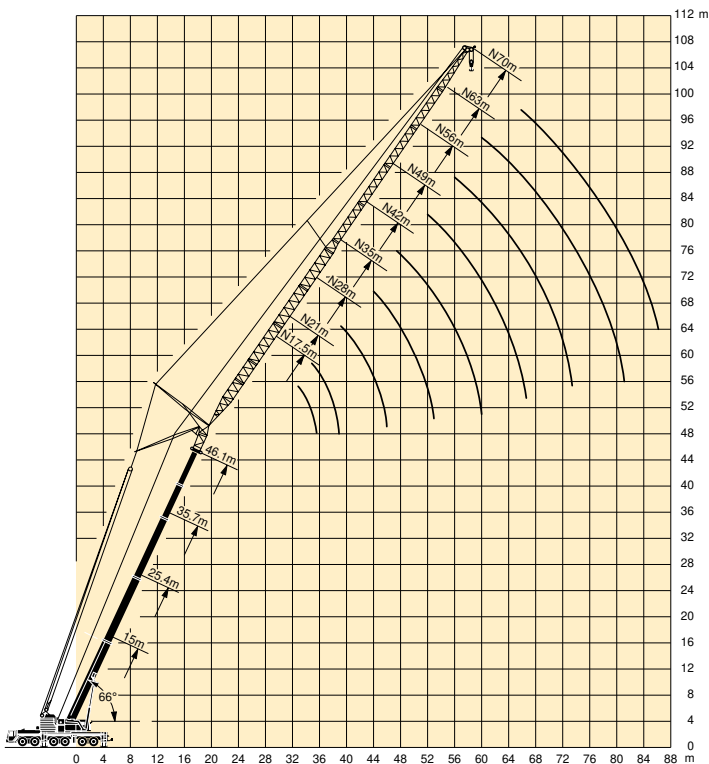

注意

- 1 定格総荷重はフックブロック、玉掛ワイヤー等の自重を含みます。
また、下記の条件が考慮されていないのでクレーンの操作には充分気をつけてください。
① 地盤の強度、地震による影響
② 作業速度に応じた動荷重および台風または強風による影響等
- 2 本機は水平に設置して、クレーン作業を行ってください。
- 3 作業半径は、クレーンの旋回中心から荷重の重心までの水平距離です。
- 4 メインブームの定格総荷重は補助ジブを取り除いた状態での値です。
- 5 152 トンを超える定格総荷重の場合は、特殊吊装置が必要です。

起伏式ジブ定格総荷重表

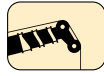

82°
15m-56.4m

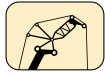

17.5m-70m

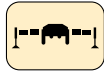

8.85m x 8.5m



360°

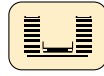

112.5t

メインブーム長さ ジブ長さ 作業半径(m)	15m+4m*									25.4m+4m*									35.7m+4m*					
	17.5m	21m	28m	35m	42m	49m	56m	63m	70m	17.5m	21m	28m	35m	42m	49m	56m	63m	70m	17.5m	21m	28m	35m		
9	78																							
10	74	69								60														
12	68	64	54							60	51										41.5			
14	63	59	51	41.5						60	50	40									41.5	35.5		
16	60	55	49	40.5	32.5					59	50	40	31								41.5	35.5	27.9	
18	50	52	46.5	39.5	32					55	50	39.5	31	24.2							40.5	35.5	27.9	21.8
20		48.5	44.5	38	31.5	24.9				50	49.5	38.5	31	24.2	18.6						38.5	35.5	27.9	21.8
22		37.5	41.5	37	30.5	24.9	19				46.5	37.5	30.5	24.2	18.6	14.1						34.5	27.9	21.8
24			38	35.5	29.9	24.4	19	14.3				37	29.7	24	18.6	14.1						33.5	27.6	21.8
26			33.5	33.5	29.2	23.7	19	14.3	10.8			36	28.9	23.6	18.6	14.1	10.9						27.2	21.8
28			27.1	31	28.3	23	18.8	14.3	10.5			33.5	28.3	23.1	18.6	14.1	10.9	8					26.8	21.6
30				28.7	27.4	22.3	18.3	14.3	10.2			27.7	27.7	22.5	18.5	14.1	10.9	8					26.7	21.3
32				26.1	25.6	21.7	17.8	14.1	9.9				27.2	22.2	18	14.1	10.9	8						21
34				21.6	23.7	21	17.3	13.8	9.6				26.6	21.4	17.5	14.1	10.9	8						20.7
36					22.3	20.4	16.8	13.6	9.4				22.3	20.9	17.1	13.9	10.9	8						20.5
38					21	19.8	16.3	13.2	9.1					20.5	16.7	13.5	10.9	7.9						20.3
40					18.4	18.5	15.8	12.9	8.9					20	16.3	13.2	10.7	7.7						
42					15.5	17.5	15.4	12.5	8.7					18.7	15.9	12.9	10.4	7.6						
44						16.6	15	12.1	8.5						15.6	12.5	10.2	7.4						
46						15.4	14.6	11.7	8.3						15.3	12.2	9.9	7.3						
48						13	13.9	11.5	8.2						15.1	12	9.8	7.1						
50							13.3	11.4	8.1						12.9	11.9	9.6	7.1						
52							12.7	11.3	8							11.8	9.5	7						
54							11.1	11.2	7.9							11.7	9.4	7						
56								10.8	7.8							11.5	9.3	6.9						
58								10.4	7.5								9.2	6.9						
60								9.4	7.2								9.2	6.9						
62								7.9	6.9								9.2	6.7						
64									6.6								7.9	6.5						
66									6.3									6.2						
68									6									6						
70																		5.8						
72																								
ブーム 伸長率 (%)	I					0												46						92
	II					0												46						46
	III					0												0						46
	IV					0												0						0

*アダプター

TAB 122354.1/2/3

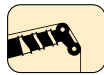

82°
15m-56.4m

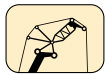

17.5m-70m

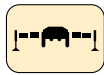

8.85m x 8.5m

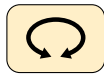

360°

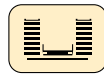

112.5t

メインブーム長さ ジブ長さ 作業半径(m)	35.7m+4m*					46.1m+4m*									56.4m+4m*									
	42m	49m	56m	63m	70m	17.5m	21m	28m	35m	42m	49m	56m	63m	70m	17.5m	21m	28m	35m	42m	49m	56m			
16						25	21.4																	
18						25	21.4	16.2																
20						25	21.4	16.2	12.1															
22						25	21.4	16.2	12.1	9.1														
24							21.4	16.2	12.1	9.1	6.6													
26							21.4	16.2	12.1	9.1	6.6													
28								16.2	12.1	9.1	6.6	4.6												
30								16.2	12.1	9.1	6.6	4.6	3.1											
32								16.2	12.1	9.1	6.6	4.6	3.1	1.8										
34								12.1	9.1	6.6	4.6	3.1	1.8											
36								12.1	9.1	6.6	4.6	3.1	1.8											
38								12.1	9.1	6.6	4.6	3.1	1.8											
40								12.1	9.1	6.6	4.6	3.1	1.8											
42									9.1	6.6	4.6	3.1	1.8											
44										9.1	6.6	4.6	3.1	1.8										
46											6.6	4.6	3.1	1.8										
48											6.6	4.6	3.1	1.8										
50											6.6	4.6	3.1	1.8										
52											6.6	4.6	3.1	1.8										
54												4.6	3.1	1.8										
56												4.6	3.1	1.8										
58												4.6	3.1	1.8										
60												4.6	3.1	1.8										
62													3.1	1.8										
64													3.1	1.8										
66														1.8										
68															1.8									
70																1.8								
72																	1.8							
ブーム 伸長率 (%)	I					92																		92
	II					46																		92
	III					46																		92
	IV					0																		92

*アダプター

TAB 122354.3/4/5

起伏式ジブ定格総荷重表

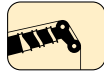

66°
15m-56.4m

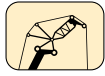

17.5m-70m

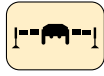

8.85m x 8.5m



360°

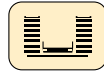

112.5t

メインブーム長さ ジブ長さ 作業半径(m)	15m+4m*									25.4m+4m*								
	17.5m	21m	28m	35m	42m	49m	56m	63m	70m	17.5m	21m	28m	35m	42m	49m	56m	63m	70m
18	51																	
20	48	46.5																
22	44.5	43																
24	41	40.5	38							37.5								
26		37.5	36							34.5	34							
28			34.5	31.5						31.5	31.5							
30			32	29.8							29.1	28.5						
32			29.7	28.6	25.9							26.5						
34			27.8	27.3	24.9							24.8	24.2					
36				25.6	24	20.8						23.2	22.7					
38				24.1	23.3	20.4						21.8	21.3	20.7				
40				22.7	22.3	20	16.7						20	19.4				
42					21	19.4	16.3							18.9	18.3	17.5		
44					19.9	18.9	16.1	12.5						17.9	17.3	16.9		
46					18.8	18.4	15.9	12.3							16.4	16	13	
48					17.7	17.4	15.7	12.3	8.2						15.5	15.1	13	
50						16.5	15.4	12.2	8.1						14.7	14.3	13	10
52						15.7	15.2	12.2	8						14	13.6	12.9	10
54						15	14.5	12.2	8							12.9	12.2	10
56							13.8	12.2	7.9							12.3	11.6	10
58							13.1	12.2	7.9							11.7	11	10
60							12.5	12	7.8							10.5	10	6.8
62							11.7	11.5	7.7							10	9.6	6.8
64								10.9	7.4							9.5	9.1	6.8
66								10.5	7.1							9.1	8.6	6.8
68								10	6.7								8.2	6.8
70									6.4								7.8	6.7
72									6.2								7.5	6.5
74									6									6.2
76									5.8									6
78																		5.8
80																		5.5
ブーム 伸長率 (%)	I					0										46		
	II					0										46		
	III					0										0		
	IV					0										0		

*アダプター

TAB 122356.1/2

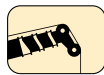

66°
15m-56.4m

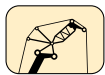

17.5m-70m

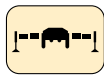

8.85m x 8.5m



360°



112.5t

メインブーム長さ ジブ長さ 作業半径(m)	35.7m+4m*									46.1m+4m*									56.4m+4m*			
	17.5m	21m	28m	35m	42m	49m	56m	63m	70m	17.5m	21m	28m	35m	42m	49m	56m	63m	70m	21m	28m	35m	42m
26	24.4	24																				
30	23.1	22.6																				
32		21.4	20.3							14.9												
34		20.5	19.2							14	13.7											
36			18.3	17.3							12.9											
38			17.5	16.4							12.2	11.3										
40			16.9	15.6	14.7						10.7	10.7							6.9			
42				15	14						10.2	9.4							6.5			
44				14.4	13.4	11.8					9.7	8.8										
46				13.9	12.9	11.8					8.4	7.7								5.2		
48				13.2	12.4	11.4	9				8	7.3							4.9			
50				11.9	10.9	9	9				7.6	6.9	6.1						4.6	3.7		
52				11.3	10.5	9	6.6				7.5	6.5	5.7							3.5		
54				10.7	10.1	9	6.6					6.2	5.4	4.4						3.3	2.8	
56					9.6	8.8	6.6	4.7				5.9	5.1	4.2						3.2	2.6	
58						9.1	8.5	6.6	4.7			5.8	4.8	4	3					3.1	2.4	
60						8.7	8.1	6.6	4.7				4.6	3.7	3						2.3	
62						8.3	7.6	6.6	4.7				4.3	3.5	3						2.2	
64							7.2	6.6	4.7				4.2	3.4	2.8	1.7					2.1	
66							6.8	6.2	4.7				4.1	3.2	2.7	1.7						
68							6.5	5.8	4.7					3.1	2.5	1.7						
70								5.5	4.6					3	2.4	1.7						
72								5.1	4.4					3	2.3	1.7						
74								4.8	4.2						2.1	1.6						
76								4.6	4						2.1	1.5						
78									3.8						2	1.4						
80									3.7						2	1.3						
82									3.5							1.2						
84																1.1						
86																1.1						
88																1.1						
ブーム 伸長率 (%)	I					92										92						
	II					46										92						
	III					46										46						
	IV					0										46						

*アダプター

TAB 122356.3/4

起伏式ジブ揚程(ガイ仕様)

オプション設定

メインブーム66°

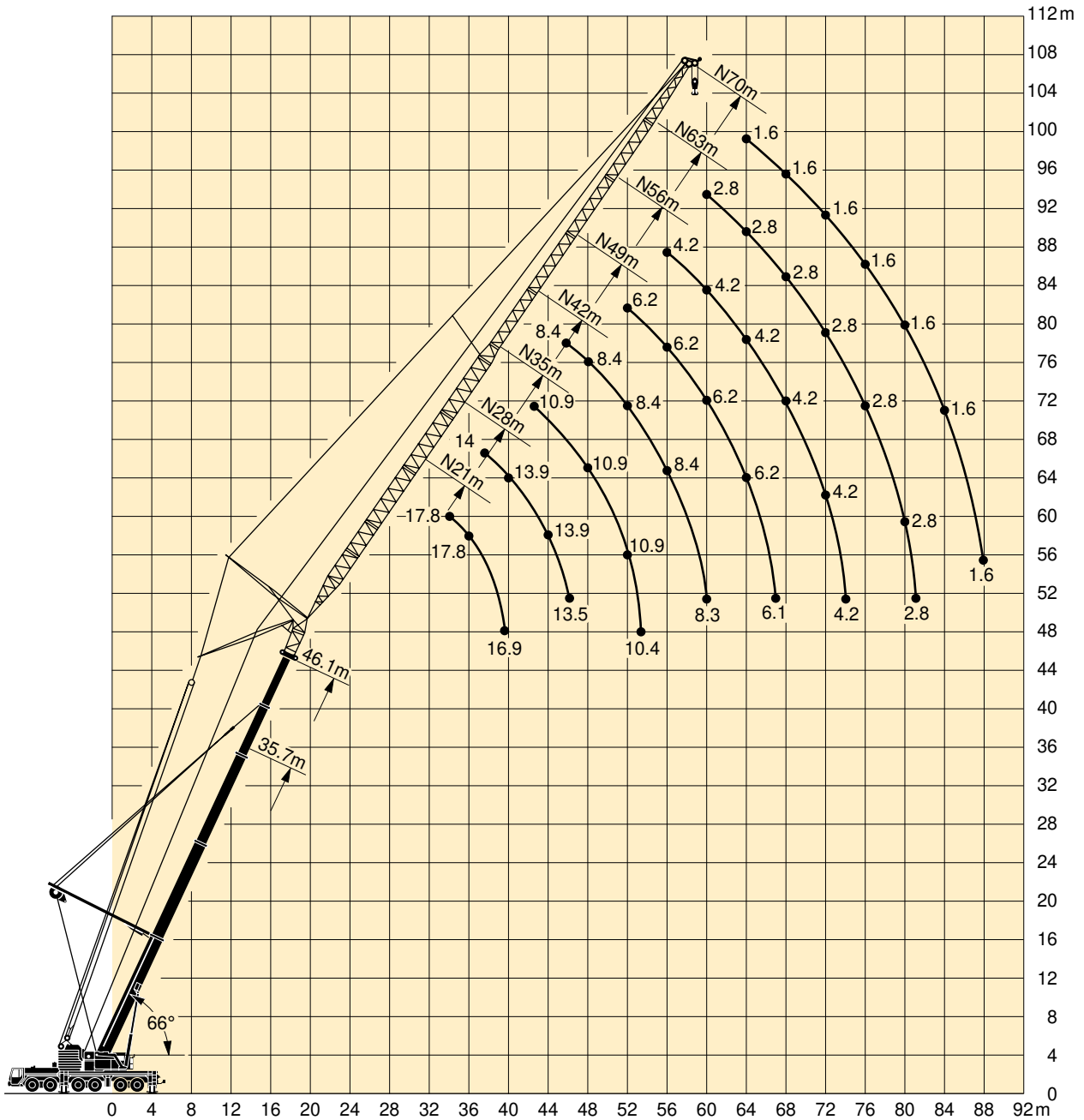

注意

- 1 定格総荷重はフックブロック、玉掛ワイヤー等の自重を含みます。
また、下記の条件が考慮されていないのでクレーンの操作には充分気をつけてください。
① 地盤の強度、地震による影響
② 作業速度に応じた動荷重および台風または強風による影響等
- 2 本機は水平に設置して、クレーン作業を行ってください。
- 3 作業半径は、クレーンの旋回中心から荷重の重心までの水平距離です。
- 4 メインブームの定格総荷重は補助ジブを取り除いた状態での値です。
- 5 152トンを超える定格総荷重の場合は、特殊吊装置が必要です。

● 起伏式ジブ定格総荷重表 (ガイ仕様) オプション設定

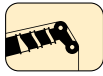

82°
35.7m-56.4m

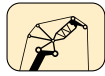

21m-70m

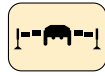

8.85m×8.5m



360°

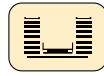

112.5t

メインブーム長さ		35.7m+4m*							46.1m+4m*			
ジブ長さ		21m	28m	35m	42m	49m	56m	63m	70m	21m	28m	35m
作業半径(m)												
14	34											
16	34		27.1							20.5		
18	33.5		26.8	21.6						20.4	15.6	
20	33		26.5	21.6	16.8					20.2	15.6	11.6
22	33		26.3	21.5	16.8	12.7				20.1	15.6	11.6
24	33		26.1	21.2	16.8	12.7				20.1	15.6	11.6
26			25.9	21	16.8	12.7	9.9			20.1	15.6	11.6
28			25.7	20.9	16.8	12.7	9.9	7.2			15.6	11.6
30			25.7	20.6	16.8	12.7	9.9	7.2	5.1		15.6	11.6
32				20.2	16.6	12.7	9.9	7.2	5.1		15.5	11.6
34				20	16.3	12.7	9.9	7.2	5.1			11.6
36				19.8	16	12.7	9.9	7.2	5.1			11.6
38				19.5	15.7	12.7	9.9	7.2	5.1			11.6
40					15.4	12.4	9.9	7.2	5.1			
42					15.1	12.1	9.8	7.2	5.1			
44					14.5	11.9	9.6	7.2	5.1			
46						11.7	9.4	7.2	5.1			
48						11.4	9.2	7.2	5.1			
50						11.2	9	7.2	5.1			
52						11	8.8	7	5.1			
54							8.6	6.9	5.1			
56							8.4	6.9	5.1			
58							8.1	6.9	5.1			
60								6.9	5.1			
62								6.9	5.1			
64								6.9	5.1			
66									5.1			
68									5.1			
70									5.1			
72									5.1			
ブーム伸長率 (%)	I								92			
	II								92			
	III								46			
	IV								0			

*アダプター

TAB 122381.1/2

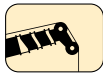

82°
35.7m-56.4m

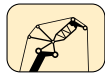

21m-70m

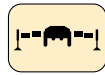

8.85m×8.5m

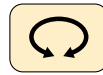

360°

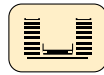

112.5t

メインブーム長さ		46.1m+4m*					56.4m+4m*					
ジブ長さ		42m	49m	56m	63m	70m	21m	28m	35m	42m	49m	56m
作業半径(m)												
18							11.6					
20							11.5	8.9				
22	8.8						11.5	8.8				
24	8.8							6.5				
26	8.8		6.5					6.5	4.6			
28	8.8		6.5	4.5				6.5	4.6			
30	8.8		6.5	4.5				6.4	4.6	3.1		
32	8.8		6.5	4.5	3	1.8		6.4	4.6	3.1	1.9	
34	8.8		6.5	4.5	3	1.8		6.4	4.6	3.1	1.9	
36	8.8		6.5	4.5	3	1.8		6.3	4.6	3.1	1.9	
38	8.8		6.5	4.5	3	1.8		6.3	4.6	3.1	1.9	
40	8.8		6.5	4.5	3	1.8		6.2	4.6	3.1	1.9	
42	8.8		6.5	4.5	3	1.8		6.2	4.6	3.1	1.9	
44	8.8		6.5	4.5	3	1.8			4.5	3.1	1.9	
46	8.8		6.5	4.5	3	1.8			4.5	3.1	1.9	
48			6.5	4.5	3	1.8			4.5	3.1	1.9	
50			6.5	4.5	3	1.8				3.1	1.9	
52			6.5	4.5	3	1.8				3.1	1.9	
54				4.5	3	1.8				3.1	1.9	
56				4.5	3	1.8					1.9	
58				4.5	3	1.8					1.9	
60				4.5	3	1.8					1.9	
62					3	1.8						
64					3	1.8						
66					3	1.8						
68					3	1.8						
70						1.8						
72						1.8						
ブーム伸長率 (%)	I						92					
	II						92					
	III						46					
	IV						46					

*アダプター

TAB 122381.2

LTM 1360N

Technical Data

起伏式ジブ定格総荷重表(ガイ仕様) オプション設定



74°
35.7m-56.4m

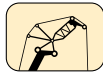

21m-70m

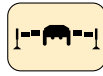

8.85m x 8.5m

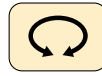

360°

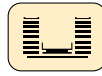

112.5t

メインブーム長さ		35.7m+4m*							46.1m+4m*			
ジブ長さ		21m	28m	35m	42m	49m	56m	63m	70m	21m	28m	35m
作業半径(m)												
22	32											
24	32											
26	31.5		25.3							19		
28	31.5		25.1	20.5						18.9	15.1	
30	29.7		25	20.3						18.9	15	
32			24.9	20.2	16.2					18.9	14.8	11.4
34			24.8	20.1	16.2						14.8	11.4
36			23.6	20	16.2	12.2					14.7	11.4
38				19.9	16.2	12.2	9.3				14.7	11.4
40				19.9	16.2	12.2	9.3				14.7	11.4
42				19.3	16.1	12.2	9.3	6.7				11.4
44				18.2	16.1	12.2	9.3	6.7	4.6			11.4
46					15.9	12.2	9.3	6.7	4.6			11.4
48					15.6	12.2	9.3	6.7	4.6			
50					15	12.2	9.3	6.7	4.6			
52						12.2	9.3	6.7	4.6			
54						12.2	9.3	6.7	4.6			
56						12.2	9.3	6.7	4.6			
58						11.9	9.3	6.7	4.6			
60							9.3	6.7	4.6			
62							9.3	6.7	4.6			
64							9.3	6.7	4.6			
66								6.7	4.6			
68								6.7	4.6			
70								6.7	4.6			
72								6.7	4.6			
74									4.6			
76									4.6			
78									4.6			
ブーム伸長率(%)	I								92			
	II								46			
	III								46			
	IV								0			

*アダプター

TAB 122382.1/2



74°
35.7m-56.4m

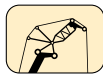

21m-70m

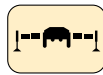

8.85m x 8.5m

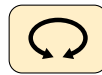

360°

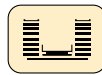

112.5t

メインブーム長さ		46.1m+4m*					56.4m+4m*					
ジブ長さ		42m	49m	56m	63m	70m	21m	28m	35m	42m	49m	56m
作業半径(m)												
30							10.6					
32							10.5	8.1				
34							10.4	8				
36	8.6						10.4	8	5.9			
38	8.6							7.9	5.9			
40	8.6		6.3					7.9	5.9	4.2		
42	8.6		6.3	4.2				7.9	5.8	4.2		
44	8.6		6.3	4.2					5.8	4.2	2.9	
46	8.6		6.3	4.2	2.8				5.8	4.2	2.9	
48	8.6		6.3	4.2	2.8				5.8	4.2	2.9	1.8
50	8.6		6.3	4.2	2.8	1.6			5.8	4.1	2.9	1.8
52	8.6		6.3	4.2	2.8	1.6				4.1	2.9	1.8
54	8.6		6.3	4.2	2.8	1.6				4.1	2.9	1.8
56			6.3	4.2	2.8	1.6				4.1	2.9	1.8
58			6.3	4.2	2.8	1.6					2.9	1.8
60			6.3	4.2	2.8	1.6					2.9	1.8
62				4.2	2.8	1.6					2.9	1.8
64				4.2	2.8	1.6					2.9	1.8
66				4.2	2.8	1.6						1.8
68				4.2	2.8	1.6						1.8
70					2.8	1.6						1.8
72					2.8	1.6						
74					2.8	1.6						
76						1.6						
78						1.6						
80						1.6						
82						1.6						
ブーム伸長率(%)	I						92					
	II						92					
	III						46					
	IV						46					

*アダプター

TAB 122382.2

起伏式ジブ定格総荷重表(ガイ仕様) オプション設定

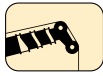

66°
35.7m-56.4m

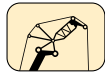

21m-70m

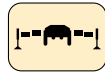

8.85m x 8.5m



360°

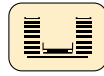

112.5t

メインブーム長さ		35.7m+4m*							46.1m+4m*			
ジブ長さ		21m	28m	35m	42m	49m	56m	63m	70m	21m	28m	35m
作業半径(m)												
30		26.4										
32		24.5										
34		22.9	22.1							17.8		
36		21.5	20.7							17.8		
38			19.4	18.9						17.8	14	
40			18.2	17.7						16.9	13.9	
42			17.2	16.7	15.6						13.9	10.9
44				15.7	15.1						13.9	10.9
46				14.9	14.2	11.7					13.5	10.9
48				14.1	13.5	11.7						10.9
50				13.4	12.8	11.7	9					10.9
52					12.1	11.5	9					10.9
54					11.5	10.9	9	6.6				10.4
56					10.9	10.3	9	6.6				
58						9.8	9	6.6	4.6			
60						9.3	8.7	6.6	4.6			
62						8.9	8.2	6.6	4.6			
64						8.5	7.8	6.6	4.6			
66							7.4	6.6	4.6			
68							7	6.3	4.6			
70							6.7	6	4.6			
72								5.6	4.6			
74								5.3	4.5			
76								5	4.3			
78								4.7	4.1			
80									3.9			
82									3.8			
84									3.6			
ブーム 伸長率 (%)	I					92					92	
	II					46					92	
	III					46					46	
	IV					0					46	

*アダプター

TAB 122383.1/2



66°
35.7m-56.4m



21m-70m

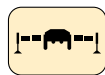

8.85m x 8.5m



360°



112.5t

メインブーム長さ		46.1m+4m*					56.4m+4m*					
ジブ長さ		42m	49m	56m	63m	70m	21m	28m	35m	42m	49m	56m
作業半径(m)												
40							9.6					
42							9.6					
44							9.6	7.4				
46		8.4						7.3				
48		8.4						7.3				
50		8.4						7.2	5.4			
52		8.4	6.2					5.4	5.4	3.9		
54		8.4	6.2					5.4	5.4	3.9		
56		8.4	6.2	4.2				5.4	5.4	3.9		
58		8.4	6.2	4.2				5.4	5.4	3.9	2.8	
60		8.3	6.2	4.2	2.8				5.4	3.9	2.8	
62			6.2	4.2	2.8					3.9	2.8	1.7
64			6.2	4.2	2.8	1.6				3.9	2.8	1.7
66			6.2	4.2	2.8	1.6					2.8	1.7
68			6.2	4.2	2.8	1.6					2.8	1.7
70			6.1	4.2	2.8	1.6					2.8	1.7
72				4.2	2.8	1.6					2.8	1.7
74				4.2	2.8	1.6					2.8	1.7
76					2.8	1.6					2.8	1.7
78					2.8	1.6					2.8	1.7
80					2.8	1.6					2.8	1.7
82					2.8	1.6					2.8	1.7
84						1.6					2.8	1.7
86						1.6					2.8	1.7
88						1.6					2.8	1.7
ブーム 伸長率 (%)	I			92						92		
	II			92						92		
	III			46						92		
	IV			46						92		

*アダプター

TAB 122383.2

主寸法

外観寸法図

単位：mm

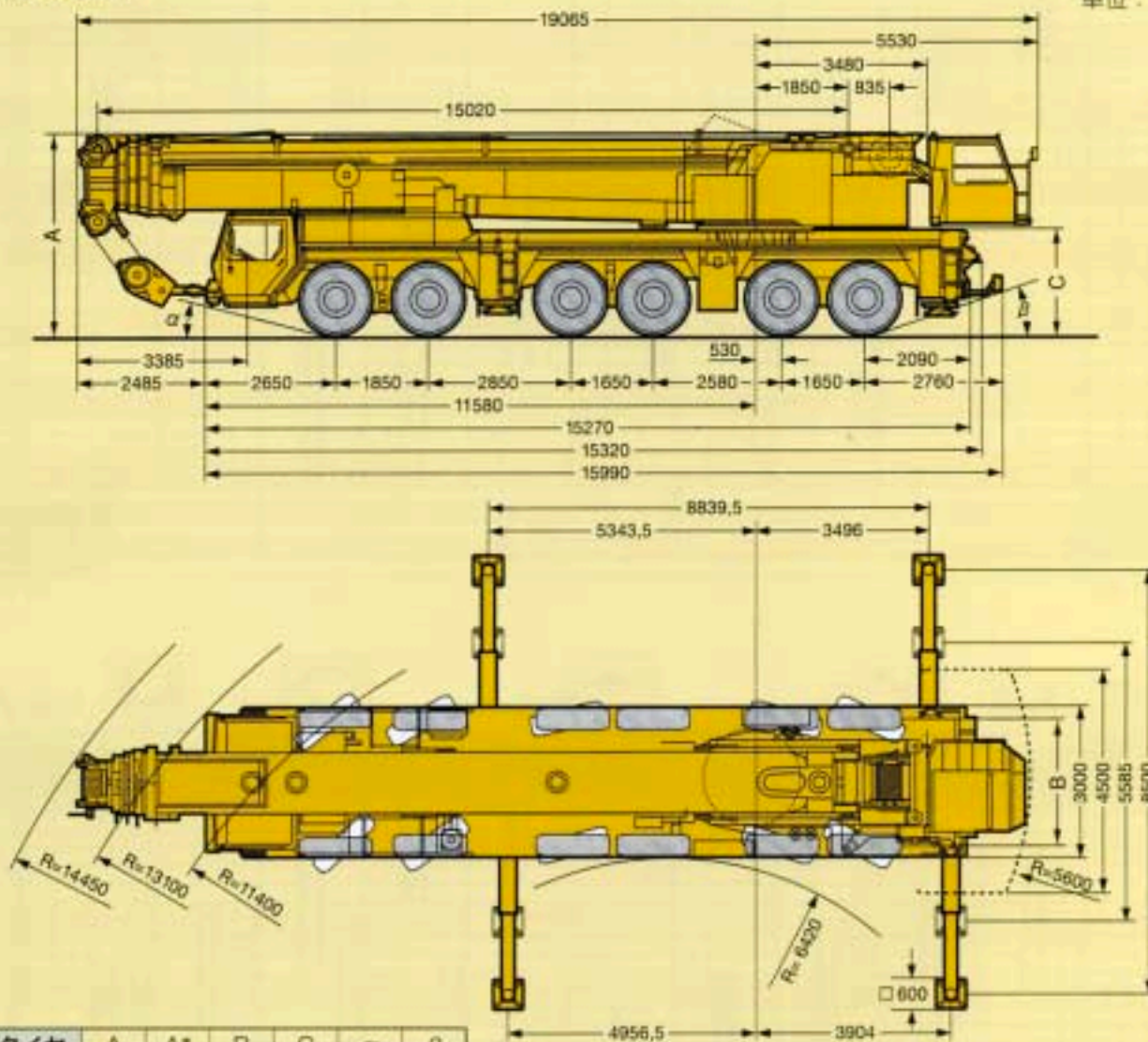

タイヤ	A	A*	B	C	α	β
14.00 R25	3950	3800	2612	2015	15°	17°
16.00 R25	4000	3850	2552	2065	17°	19°

*サスペンションを150mm下げた状態

本機は、公道を走行する場合、道路運送車両法を遵守し走行してください。

リープヘル・ジャパン株式会社

〒230-0053 横浜市鶴見区大黒町5番39号

TEL. 045-505-8687 (営業)
045-505-8689 (サービス)

FAX. 045-505-8683

なお、本仕様は予告なく変更することがあります。
使用上の注意等は操作マニュアルをご参照ください。

TP278e.5.00
2004.11.1000