

Mastertech 7090

KOBELCO

マスターテック

# Mastertech

## 7090

クローラクレーン

最大つり上げ能力 **90t × 4.3m**

ラフティングタワー

最大つり上げ能力 **15t × 14.0m**

オフロード法適合



*MasterTech*  
**7090**

型式名 7090-1F

# クローラクレーン

**最大定格総荷重90t×4.3m**

▶主要諸元	1
▶フック巻上限界	1
▶仕様とアタッチメント	1
<b>クローラクレーン</b>	
▶全体図	2
▶ブーム構成	3
▶ジブ構成	4
▶作動範囲図	5
▶定格総荷重	6
▶主ブーム定格総荷重表	7
▶補助シーブ定格総荷重表	8, 9
▶ジブ定格総荷重表	10, 11
<b>ラフティングタワー</b>	
▶全体図	12
▶タワー構成	13
▶タワージブ構成	13
▶定格総荷重	14
▶タワー長さ26.0m	15
▶タワー長さ29.1m	16
▶タワー長さ32.1m	17
▶タワー長さ35.2m	18
▶タワー長さ38.2m	19
▶タワー長さ41.2m	20
▶タワー長さ44.3m	21
▶分解時の寸法・質量	22

## ▶ブーム構成

- 印は、ジブ使用時のガイドライン取付位置を示します。
- \*印は、これより短いブームの組立可能な構成を示します。
- 使用するガイドラインの径はφ34mmです。
- ジブ付の場合は9.1mラグ付中間ブーム(9.1A)が必要で  
す。また、ジブなしの場合は、図中の9.1Aは9.1の使用も可能  
です。
- 9.1Bはタワー用ですがクレーンにも転用できます。

中間ブームの種類		
記号	ブーム長さ	備考
3.0	3.0m	ラグ無
6.1	6.1m	ラグ無
9.1	9.1m	ラグ無
9.1A	9.1m	ラグ付
9.1B	9.1m	タワー専用 (クレーンに兼用可能)

ブーム長さ m (ft.)	ブーム構成
13.8 (45)	
16.9 (55)	
19.9 (65)	*
23.0 (75)	*
26.0 (85)	*
29.1 (95)	*
32.1 (105)	*
35.2 (115)	*
38.2 (125)	*

ブーム長さ m (ft.)	ブーム構成
41.2 (135)	*
44.3 (145)	*
47.3 (155)	*
50.4 (165)	*
53.4 (175)	*

ブーム長さ m (ft.)	ブーム構成
56.5 (185)	* 
59.5 (195)	* 
62.6 (205)	* 

### ジブ構成

- ジブを装着できる主ブームの長さは、29.1m (95) ~ 53.4m (175) です。
- ジブを装着する場合には9.1mラグ付中間ブーム (9.1A) が必要です。

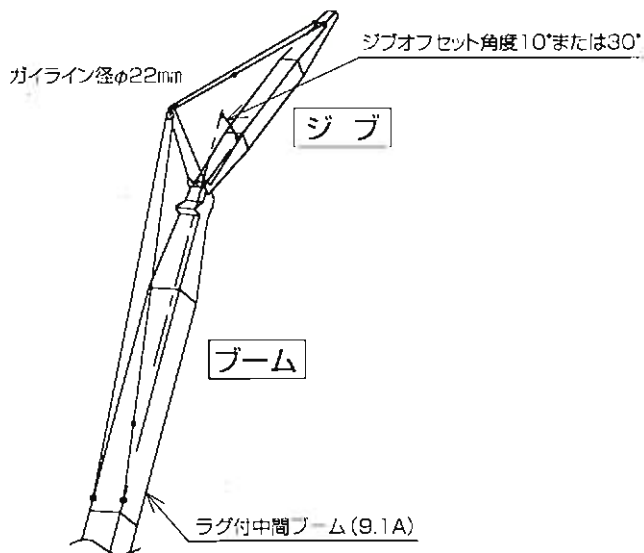

ジブ長さ m(ft.)	ジブ構成
9.1 (30)	
15.2 (50)	
21.3 (70)	

▶作動範囲図

■主ブーム

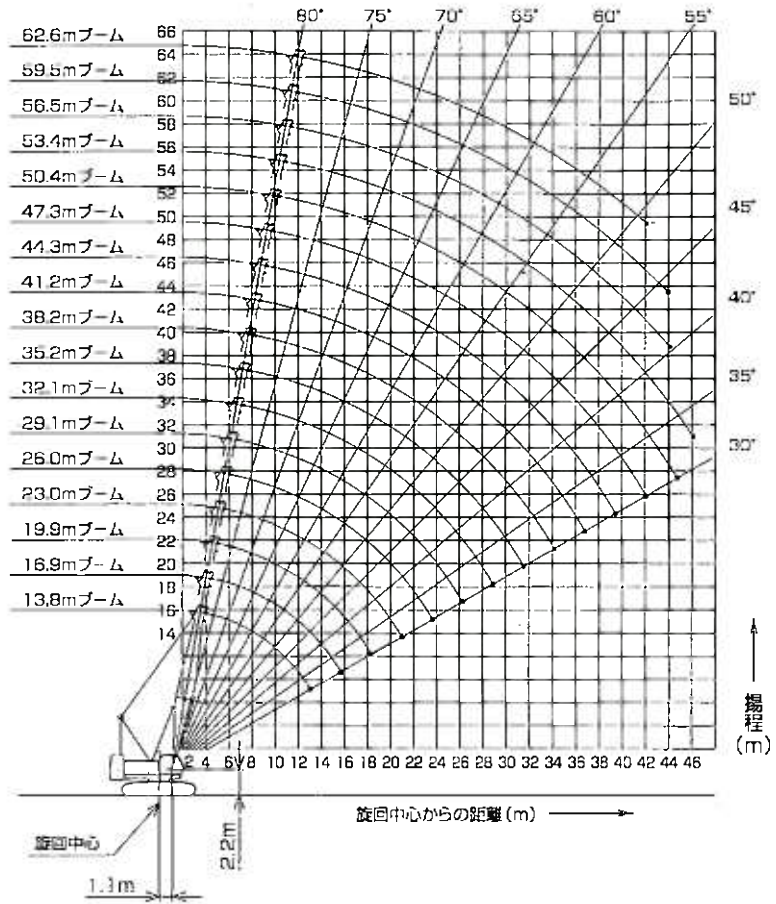

■ジブ装着  
(オフセット角度10°/30°)

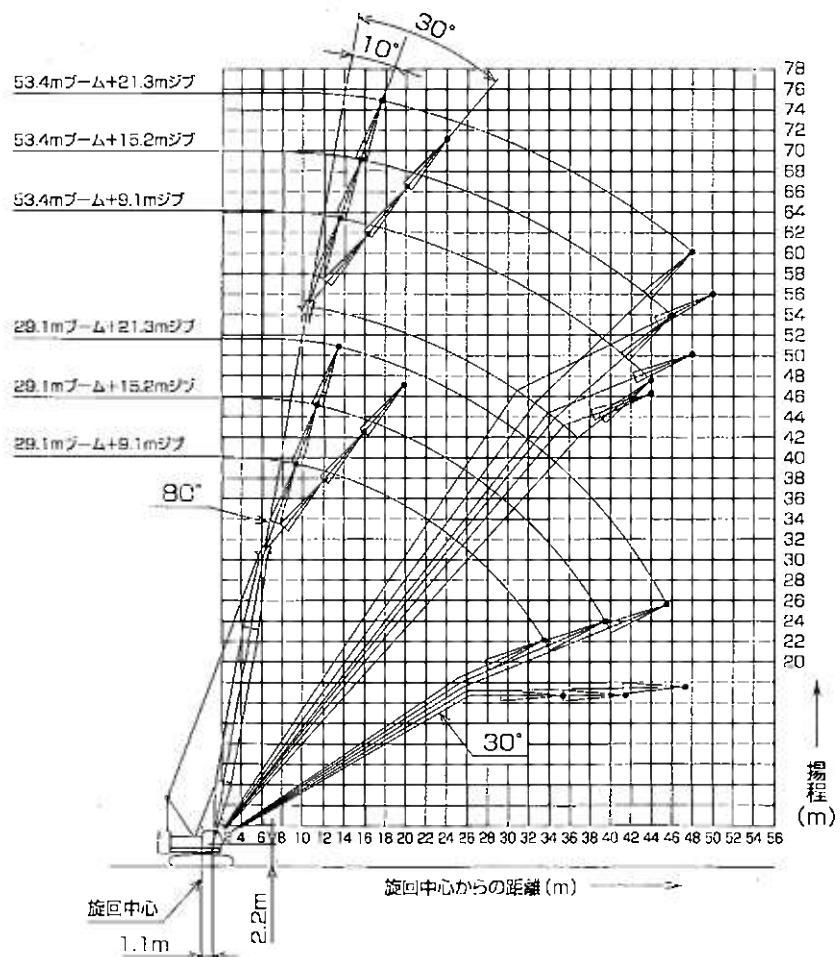

## ▶ 定格総荷重

- 定格総荷重とは、水平堅土上における転倒荷重の78%以内で、フックブロック、玉掛用ワイヤロープ等のつり具の質量を含んだ値です。
- 作業半径とはクレーン旋回中心よりつり上荷重の重心までの水平距離を意味します。
- 実際につり上げ得る荷重は定格総荷重から（フック+玉掛用ワイヤロープ等のつり具）の質量を差し引いた値になります。
- 定格総荷重をつる場合にも風の影響、地盤の状態、作業速度その他安全作業に有害な状況がある時はオペレータは荷重の軽減、作業速度を遅くするなど状況に応じた判断をする責任があります。
- 表中の空欄の箇所では作業を行うことができません。
- クレーン作業中には必ずガントリを最高位置に立ててください。
- すべてのブーム（ジブ）長さにおける中間ブーム（ジブ）の構成は取扱説明書の指示を厳守してください。
- 主ブームに補助シーブを取り付けたままで主フックを使用する場合の定格総荷重は、主ブーム定格総荷重から、一律0.8t差し引いた値となります。ただし最小定格総荷重は1.5tとします。
- 補助シーブを装着できる主ブーム長さは、13.8m（45）～59.5m（195）です。
- ジブを装着できる主ブーム長さは、29.1m（95）～53.4m（175）です。
- 下記の仕様ではブーム自立および降下の際にクローラの前端に敷板（ブロック）を敷いてください。  
 ※主ブーム長さ 59.5m（195）および62.6m（205）  
 ※53.4m（175）ブームにジブを装着した場合
- △ 操作ミスなどによるつり荷の落下を防ぐため、クレーン作業では自由降下（フリーフォール）作業は行わないでください。

### ● 巻上げロープ巻掛本数に対する最大巻上荷重とフックの質量

フック 呼称	最大巻上荷重 (t)								フック 質量
	1本掛	2本掛	3本掛	4本掛	5本掛	6本掛	7本掛	8本掛	
90t	-	-	33.0	44.0	55.0	66.0	77.0	90.0	1.30t
50t	-	-	33.0	44.0	50.0	-	-	-	0.85t
35t	-	22.0	33.0	-	-	-	-	-	0.70t
11t ボールフック	11.0	-	-	-	-	-	-	-	0.30t

▶主ブーム定格総荷重表

(単位:t)

ブーム長さ (m) 標準(m)	13.8	16.9	19.9	23.0	26.0	29.1	32.1	35.2	38.2	41.2	44.3	47.3	50.4	53.4	56.5	59.5	62.6	ブーム長さ (m) 標準(m)
4.3	93.0/4.3m	87.5/4.3m	74.1/4.8m															4.3
5.0	70.9	70.8	70.7	64.9/5.4m	56.4/5.9m													5.0
6.0	55.1	55.0	55.0	54.9	54.8	50.2/6.4m												6.0
7.0	44.4	44.3	44.1	44.1	44.0	44.0	43.9	38.6/7.5m										7.0
8.0	36.6	36.5	36.3	36.2	36.1	36.1	36.0	35.9	35.7	32.5/8.5m								8.0
9.0	31.0	30.9	30.7	30.7	30.5	30.5	30.4	30.3	30.2	30.2	29.7/9.1m	27.2/9.6m						9.0
10.0	26.9	26.7	26.6	26.5	26.4	26.3	26.3	26.1	26.0	26.0	25.8	25.7	22.0/10.1m	22.0/10.7m	21.6/11.2m	20.1/11.7m		10.0
12.0	21.1	21.0	20.8	20.7	20.6	20.5	20.4	20.3	20.2	20.1	20.0	19.8	19.8	19.7	19.5	19.4	18.0/12.2m	12.0
14.0	18.7/13.2m	17.1	16.9	16.9	16.7	16.6	16.6	16.4	16.3	16.2	16.1	16.0	15.9	15.8	15.6	15.5	15.4	14.0
16.0		14.6/15.8m	14.2	14.1	14.0	13.9	13.8	13.7	13.5	13.5	13.3	13.2	13.2	13.0	12.9	12.7	12.6	16.0
18.0			12.2	12.1	11.9	11.9	11.8	11.6	11.5	11.4	11.2	11.1	11.1	10.9	10.8	10.7	10.5	18.0
20.0			11.8/18.5m	10.5	10.4	10.3	10.2	10.0	9.9	9.8	9.6	9.5	9.5	9.3	9.2	9.1	8.9	20.0
22.0				9.8/21.1m	9.1	9.0	8.9	8.7	8.6	8.5	8.4	8.2	8.2	8.0	7.9	7.8	7.6	22.0
24.0					8.2/23.8m	8.0	7.9	7.7	7.6	7.5	7.3	7.2	7.1	7.0	6.9	6.7	6.6	24.0
26.0						7.2	7.0	6.8	6.7	6.6	6.5	6.3	6.3	6.1	6.0	5.8	5.7	26.0
28.0						7.0/26.4m	6.3	6.1	6.0	5.9	5.7	5.6	5.5	5.4	5.2	5.1	4.9	28.0
30.0							5.0/29.0m	5.5	5.4	5.3	5.1	5.0	4.9	4.7	4.6	4.5	4.3	30.0
32.0								5.1/31.7m	4.8	4.8	4.6	4.4	4.4	4.2	4.1	3.9	3.8	32.0
34.0									4.4	4.3	4.1	4.0	3.9	3.7	3.6	3.4	3.2	34.0
36.0									4.3/34.3m	3.9	3.7	3.5	3.5	3.3	3.2	3.0	2.7	36.0
38.0										3.7/37.0m	3.3	3.2	3.1	2.9	2.7	2.5	2.3	38.0
40.0											3.1/39.6m	2.9	2.8	2.5	2.3	2.1	1.9	40.0
42.0												2.5	2.4	2.2	2.0	1.8	1.5	42.0
44.0													2.5/42.2m	2.1	1.8	1.5		44.0
46.0														2.0/44.9m	1.6			46.0

※表中の太線で囲まれた部分は、ブーム等の強度によって定められた値です。

▶ 補助シーブ定格総荷重表 (主ブームに90tフック装着)

(単位:t)

ブーム長さ (m) 作業半径(m)	13.8	16.9	19.9	23.0	26.0	29.1	32.1	35.2	38.2	41.2	44.3	47.3	50.4	53.4	56.5	59.5	ブーム長さ (m) 作業半径(m)
5.0	11.0/5.2m	11.0/5.2m	11.0/5.7m														5.0
6.0	11.0	11.0	11.0	11.0/6.3m	11.0/6.6m												6.0
7.0	11.0	11.0	11.0	11.0	11.0	11.0/7.3m	11.0/7.9m										7.0
8.0	11.0	11.0	11.0	11.0	11.0	11.0	11.0	11.0/8.4m	11.0/8.9m								8.0
9.0	11.0	11.0	11.0	11.0	11.0	11.0	11.0	11.0	11.0	11.0/9.4m							9.0
10.0	11.0	11.0	11.0	11.0	11.0	11.0	11.0	11.0	11.0	11.0	11.0/10.0m	11.0/10.5m	11.0/11.0m	11.0/11.5m			10.0
12.0	11.0	11.0	11.0	11.0	11.0	11.0	11.0	11.0	11.0	11.0	11.0	11.0	11.0	11.0	11.0/12.1m	11.0/12.6m	12.0
14.0	11.0	11.0	11.0	11.0	11.0	11.0	11.0	11.0	11.0	11.0	11.0	11.0	11.0	11.0	11.0	11.0	14.0
16.0	11.0/14.6m	11.0	11.0	11.0	11.0	11.0	11.0	11.0	11.0	11.0	11.0	11.0	11.0	11.0	11.0	11.0	16.0
18.0		9.2/17.2m	10.5	10.4	10.2	10.2	10.1	9.9	9.8	9.7	9.5	9.4	9.4	9.2	9.1	9.0	18.0
20.0			8.6/19.9m	8.8	8.7	8.6	8.5	8.3	8.2	8.1	7.9	7.8	7.8	7.6	7.5	7.4	20.0
22.0				7.2	7.4	7.3	7.2	7.0	6.9	6.8	6.7	6.5	6.5	6.3	6.2	6.1	22.0
24.0				6.8/22.5m	6.1	6.3	6.2	6.0	5.9	5.8	5.6	5.5	5.4	5.3	5.2	5.0	24.0
26.0					5.3/25.2m	5.5	5.3	5.1	5.0	4.9	4.8	4.6	4.6	4.4	4.3	4.1	26.0
28.0						4.8/27.8m	4.6	4.4	4.3	4.2	4.0	3.9	3.8	3.7	3.5	3.4	28.0
30.0							3.9	3.8	3.7	3.6	3.4	3.3	3.2	3.0	2.9	2.8	30.0
32.0								3.8/30.4m	3.2	3.1	3.1	2.9	2.7	2.5	2.4	2.2	32.0
34.0									2.9/33.1m	2.7	2.6	2.4	2.3	2.2	2.0	1.9	34.0
36.0										2.4/35.7m	2.2	2.0	1.8	1.8	1.6	1.5	36.0
38.0											1.8	1.6	1.5				38.0
40.0											1.7/38.4m						40.0

※表中の太線で囲まれた部分は、ブーム等の強度によって定められた値です。

▶ 補助シーブ定格総荷重表 (主ブームに50tフック装着)

(単位:t)

ブーム長さ (m) 作業半径(m)	13.8	16.9	19.9	23.0	26.0	29.1	32.1	35.2	38.2	41.2	44.3	47.3	50.4	53.4	56.5	59.5	ブーム長さ (m) 作業半径(m)
5.0	11.0/5.2m	11.0/5.2m	11.0/5.7m														5.0
6.0	11.0	11.0	11.0	11.0/6.3m	11.0/6.6m												6.0
7.0	11.0	11.0	11.0	11.0	11.0	11.0/7.3m	11.0/7.9m										7.0
8.0	11.0	11.0	11.0	11.0	11.0	11.0	11.0	11.0/8.4m	11.0/8.9m								8.0
9.0	11.0	11.0	11.0	11.0	11.0	11.0	11.0	11.0	11.0	11.0/9.4m							9.0
10.0	11.0	11.0	11.0	11.0	11.0	11.0	11.0	11.0	11.0	11.0	11.0/10.0m	11.0/10.5m	11.0/11.0m	11.0/11.5m			10.0
12.0	11.0	11.0	11.0	11.0	11.0	11.0	11.0	11.0	11.0	11.0	11.0	11.0	11.0	11.0	11.0/12.1m	11.0/12.6m	12.0
14.0	11.0	11.0	11.0	11.0	11.0	11.0	11.0	11.0	11.0	11.0	11.0	11.0	11.0	11.0	11.0	11.0	14.0
16.0	11.0/14.6m	11.0	11.0	11.0	11.0	11.0	11.0	11.0	11.0	11.0	11.0	11.0	11.0	11.0	11.0	11.0	16.0
18.0		9.7/17.2m	10.9	10.8	10.6	10.5	10.4	10.2	10.0	10.0	9.8	9.7	9.6	9.4	9.3	9.2	18.0
20.0			9.0/19.9m	9.2	9.0	8.9	8.8	8.6	8.5	8.4	8.2	8.1	8.0	7.8	7.7	7.6	20.0
22.0				7.6	7.8	7.7	7.6	7.3	7.2	7.1	7.0	6.8	6.7	6.6	6.4	6.3	22.0
24.0				7.2/22.5m	6.6	6.7	6.6	6.3	6.2	6.1	5.9	5.8	5.7	5.5	5.4	5.3	24.0
26.0					5.9/25.2m	5.8	5.7	5.5	5.3	5.2	5.1	4.9	4.8	4.7	4.5	4.4	26.0
28.0						5.0/27.8m	5.0	4.7	4.6	4.5	4.3	4.2	4.1	3.9	3.8	3.7	28.0
30.0							4.3	4.1	4.0	3.9	3.7	3.6	3.5	3.3	3.2	3.1	30.0
32.0								4.2/30.4m	3.5	3.5	3.4	3.2	3.0	2.8	2.7	2.5	32.0
34.0									3.2/33.1m	3.0	2.9	2.7	2.6	2.5	2.3	2.0	34.0
36.0										2.6/35.7m	2.5	2.3	2.2	2.1	1.9	1.7	36.0
38.0											2.1	2.0	1.8	1.7	1.5		38.0
40.0											2.0/38.4m	1.7	1.5				40.0
42.0												1.6/41.0m					42.0

※表中の太線で囲まれた部分は、ブーム等の強度によって定められた値です。

▶ 補助シーブ定格総荷重表 (主ブームに35tフック装着)

(単位:t)

ブーム長さ 作業半径(m)	13.8	16.9	19.9	23.0	26.0	29.1	32.1	35.2	38.2	41.2	44.3	47.3	50.4	53.4	56.5	59.5	ブーム長さ 作業半径(m)
5.0	11.0/5.2m	11.0/5.2m	11.0/5.7m														5.0
6.0	11.0	11.0	11.0	11.0/6.3m	11.0/6.8m												6.0
7.0	11.0	11.0	11.0	11.0	11.0	11.0/7.3m	11.0/7.9m										7.0
8.0	11.0	11.0	11.0	11.0	11.0	11.0	11.0	11.0/8.4m	11.0/8.9m								8.0
9.0	11.0	11.0	11.0	11.0	11.0	11.0	11.0	11.0	11.0	11.0/9.4m							9.0
10.0	11.0	11.0	11.0	11.0	11.0	11.0	11.0	11.0	11.0	11.0	11.0/10.0m	11.0/10.5m	11.0/11.0m	11.0/11.5m			10.0
12.0	11.0	11.0	11.0	11.0	11.0	11.0	11.0	11.0	11.0	11.0	11.0	11.0	11.0	11.0	11.0/12.1m	11.0/12.6m	12.0
14.0	11.0	11.0	11.0	11.0	11.0	11.0	11.0	11.0	11.0	11.0	11.0	11.0	11.0	11.0	11.0	11.0	14.0
16.0	11.0/14.5m	11.0	11.0	11.0	11.0	11.0	11.0	11.0	11.0	11.0	11.0	11.0	11.0	11.0	11.0	11.0	16.0
18.0		9.8/17.2m	11.0	11.0	10.8	10.8	10.7	10.5	10.4	10.3	10.1	10.0	10.0	9.8	9.7	9.6	18.0
20.0			9.2/19.9m	9.4	9.3	9.2	9.1	8.9	8.8	8.7	8.5	8.4	8.4	8.2	8.1	8.0	20.0
22.0				7.8	8.0	7.9	7.8	7.6	7.5	7.4	7.3	7.1	7.1	6.9	6.8	6.7	22.0
24.0				7.4/22.5m	6.7	6.9	6.8	6.6	6.5	6.4	6.2	6.1	6.0	5.9	5.8	5.6	24.0
26.0					5.9/25.2m	6.1	5.9	5.7	5.6	5.5	5.4	5.2	5.2	5.0	4.9	4.7	26.0
28.0						5.4/27.8m	5.2	5.0	4.9	4.8	4.6	4.5	4.4	4.3	4.1	4.0	28.0
30.0							4.5	4.4	4.3	4.2	4.0	3.9	3.8	3.6	3.5	3.4	30.0
32.0							4.4/30.4m	3.8	3.7	3.7	3.5	3.3	3.3	3.1	3.0	2.8	32.0
34.0								3.5/33.1m	3.3	3.2	3.0	2.9	2.8	2.6	2.5	2.3	34.0
36.0									3.0/35.7m	2.8	2.6	2.4	2.4	2.2	2.1	1.9	36.0
38.0										2.4	2.2	2.1	2.0	1.8	1.6		38.0
40.0										2.3/38.4m	1.8	1.8	1.7				40.0
42.0											1.6/41.0m						42.0

※表中の太線で囲まれた部分は、ブーム等の強度によって定められた値です。

▶ 補助シーブ定格総荷重表 (主ブームにフックなし)

(単位:t)

ブーム長さ 作業半径(m)	13.8	16.9	19.9	23.0	26.0	29.1	32.1	35.2	38.2	41.2	44.3	47.3	50.4	53.4	56.5	59.5	ブーム長さ 作業半径(m)
5.0	11.0/5.2m	11.0/5.2m	11.0/5.7m														5.0
6.0	11.0	11.0	11.0	11.0/6.3m	11.0/6.8m												6.0
7.0	11.0	11.0	11.0	11.0	11.0	11.0/7.3m	11.0/7.9m										7.0
8.0	11.0	11.0	11.0	11.0	11.0	11.0	11.0	11.0/8.4m	11.0/8.9m								8.0
9.0	11.0	11.0	11.0	11.0	11.0	11.0	11.0	11.0	11.0	11.0/9.4m							9.0
10.0	11.0	11.0	11.0	11.0	11.0	11.0	11.0	11.0	11.0	11.0	11.0/10.0m	11.0/10.5m	11.0/11.0m	11.0/11.5m			10.0
12.0	11.0	11.0	11.0	11.0	11.0	11.0	11.0	11.0	11.0	11.0	11.0	11.0	11.0	11.0	11.0/12.1m	11.0/12.6m	12.0
14.0	11.0	11.0	11.0	11.0	11.0	11.0	11.0	11.0	11.0	11.0	11.0	11.0	11.0	11.0	11.0	11.0	14.0
16.0	11.0/14.5m	11.0	11.0	11.0	11.0	11.0	11.0	11.0	11.0	11.0	11.0	11.0	11.0	11.0	11.0	11.0	16.0
18.0		10.3/17.2m	11.0	11.0	11.0	11.0	11.0	11.0	11.0	11.0	10.8	10.7	10.7	10.5	10.4	10.3	18.0
20.0			9.9/19.9m	10.1	10.0	9.9	9.8	9.6	9.5	9.4	9.2	9.1	9.1	8.9	8.8	8.7	20.0
22.0				8.5	8.7	8.6	8.5	8.3	8.2	8.1	8.0	7.8	7.8	7.6	7.5	7.4	22.0
24.0				8.1/22.5m	7.4	7.6	7.5	7.3	7.2	7.1	6.9	6.8	6.7	6.6	6.5	6.3	24.0
26.0					6.6/25.2m	6.8	6.6	6.4	6.3	6.2	6.1	5.9	5.9	5.7	5.6	5.4	26.0
28.0						6.1/27.8m	5.9	5.7	5.6	5.5	5.3	5.2	5.1	5.0	4.8	4.7	28.0
30.0							5.2	5.1	5.0	4.9	4.7	4.6	4.5	4.3	4.2	4.1	30.0
32.0							5.1/30.4m	4.5	4.4	4.4	4.2	4.0	4.0	3.8	3.7	3.5	32.0
34.0								4.2/33.1m	4.0	3.9	3.7	3.6	3.5	3.3	3.2	3.0	34.0
36.0									3.7/35.7m	3.5	3.3	3.1	3.1	2.9	2.8	2.6	36.0
38.0										3.1	2.9	2.8	2.7	2.5	2.3	2.1	38.0
40.0										3.0/38.4m	2.5	2.5	2.4	2.1	1.9	1.7	40.0
42.0											2.3/41.0m	2.1	2.0	1.8	1.6		42.0
44.0												1.8/43.6m	1.7				44.0
46.0													1.6				46.0

※表中の太線で囲まれた部分は、ブーム等の強度によって定められた値です。

■ジブ定格総荷重表 (主ブームに50tまたは35tフック装着/ジブオフセット角度10°)

ブーム長さ(m) ジブ長さ(m) 総長さ(m)	29.1			32.1			35.2			38.2			41.2			44.3			47.3			50.4			53.4			ブーム長さ(m) ジブ長さ(m) 総長さ(m)	
	9.1	15.2	21.3	9.1	15.2	21.3	9.1	15.2	21.3	9.1	15.2	21.3	9.1	15.2	21.3	9.1	15.2	21.3	9.1	15.2	21.3	9.1	15.2	21.3	9.1	15.2	21.3		
9.0	110	64																									9.0		
10.0	110	31/117r		110	121		110	127r		110	12r		110	117m													10.0		
12.0	110	9.1	64/136r	110	31/122r		110	31/126r		110	31/132m		110	31/138r	110	31/142r		110	31/147r		110	31/153m		110	31/159r		12.0		
14.0	110	9.1	6.1	110	9.1	62/143m	110	9.1	62/149r	110	9.1	63/154m	110	9.1	63/159m	110	9.1	63/164r	110	9.1	63/169m	110	9.1	63/175r	110	9.1	14.0		
16.0	110	9.1	6.0	110	9.1	6.0	110	9.1	6.1	110	9.1	6.1	110	9.1	6.1	110	9.1	6.1	110	9.1	6.1	110	9.1	6.1	110	9.1	16.0		
18.0	110	9.1	5.8	110	9.1	5.8	109	9.1	5.9	108	9.1	5.9	106	9.1	6.0	105	9.1	6.0	103	9.1	6.1	102	9.1	6.1	101	9.1	6.1	18.0	
20.0	96	88	5.6	94	9.1	5.7	93	9.1	5.7	91	9.1	5.8	90	9.1	5.8	88	9.1	5.9	87	9.0	5.9	86	8.8	6.0	84	8.7	6.0	20.0	
22.0	83	80	5.4	81	8.3	5.5	80	8.2	5.6	78	8.0	5.6	77	7.9	5.7	75	7.8	5.7	74	7.6	5.8	7.3	7.5	5.8	7.1	7.4	5.9	22.0	
24.0	72	73	5.2	71	7.3	5.3	69	7.1	5.4	68	7.0	5.5	66	6.8	5.6	65	6.7	5.6	63	6.6	5.7	6.2	6.4	5.7	6.0	6.3	5.7	24.0	
26.0	63	55	4.9	62	6.4	5.1	60	6.2	5.2	59	6.1	5.3	57	5.9	5.4	5.6	5.8	5.5	5.4	5.7	5.5	5.3	5.5	5.6	5.1	5.4	5.6	26.0	
28.0	56	58	4.5	54	5.6	4.8	53	5.5	5.0	5.1	5.3	5.1	5.0	5.2	5.2	4.8	5.0	5.3	4.7	4.9	5.2	4.5	4.8	5.1	4.4	4.6	4.9	28.0	
30.0	50	5.1	4.1	4.8	5.0	4.4	4.6	4.8	4.6	4.5	4.7	4.9	4.4	4.5	4.8	4.2	4.4	4.6	4.0	4.2	4.5	3.9	4.1	4.4	3.7	3.9	4.3	30.0	
32.0	44	4.6	3.8	4.3	4.4	4.0	4.1	4.3	4.3	3.9	4.1	4.3	3.8	4.0	4.2	3.6	3.8	4.1	3.5	3.7	4.0	3.3	3.5	3.8	3.2	3.4	3.7	32.0	
34.0	3.9	4.1	3.5	3.8	3.9	3.7	3.6	3.8	4.0	3.5	3.6	3.9	3.3	3.5	3.7	3.1	3.3	3.6	3.0	3.2	3.5	2.9	3.0	3.3	2.7	2.9	3.2	34.0	
36.0		3.7	3.3	3.4	3.5	3.5	3.2	3.3	3.5	3.0	3.2	3.4	2.9	3.1	3.3	2.7	2.9	3.1	2.6	2.8	3.0	2.4	2.6	2.9	2.3	2.4	2.7	36.0	
38.0		3.3	3.0		3.1	3.2	2.8	3.0	3.2	2.7	2.8	3.0	2.5	2.7	2.9	2.3	2.5	2.7	2.2	2.4	2.6	2.0	2.2	2.5	1.8	2.0	2.3	38.0	
40.0		2.9	2.8		2.8	3.0	2.5	2.6	2.8	2.3	2.5	2.7	2.2	2.3	2.5	2.0	2.2	2.4	1.8	2.0	2.3	1.6	1.9	2.1		1.6	2.0	40.0	
42.0			2.5		2.5	2.7		2.3	2.5	2.0	2.2	2.4	1.9	2.0	2.2	1.7	1.9	2.1	1.5	1.7	2.0		1.5	1.8			1.8	42.0	
44.0			2.5		2.4		2.0	2.2		1.9	2.1	1.6	1.8	2.0		1.6	1.8			1.7			1.5					44.0	
46.0			2.2		2.1		1.8	2.0		1.7	1.8		1.5	1.7			1.5												46.0
48.0					1.9			1.7			1.6			1.5															48.0
50.0								1.5																					50.0

※表中の太線で囲まれた部分は、ブーム等の強度によって定められた値です。

■ジブ定格総荷重表 (主ブームに50tまたは35tフック装着/ジブオフセット角度30°)

ブーム長さ(m) ジブ長さ(m) 総長さ(m)	29.1			32.1			35.2			38.2			41.2			44.3			47.3			50.4			53.4			ブーム長さ(m) ジブ長さ(m) 総長さ(m)	
	9.1	15.2	21.3	9.1	15.2	21.3	9.1	15.2	21.3	9.1	15.2	21.3	9.1	15.2	21.3	9.1	15.2	21.3	9.1	15.2	21.3	9.1	15.2	21.3	9.1	15.2	21.3		
12.0	95/124m			95/129m			95/134m																					12.0	
14.0	9.5			9.5			9.5			9.5			9.5/147r			9.5/151m			9.5/155m									14.0	
16.0	9.5	62/163m		9.5	62/168m		9.5	62/174m		9.5	62/179r		9.5			9.5			9.5			9.5/181m		9.5/185m		9.5		16.0	
18.0	9.4	5.2		9.5	5.2		9.5	5.2		9.5	5.2		9.5	62/184r		9.5	62/189r		9.5	62/195r		9.5			9.5			18.0	
20.0	8.8	5.2	37/202m	9.1	5.2	37/207m	9.4	5.2	37/213m	9.5	5.2	37/218m	9.4	5.2		9.2	5.2		9.1	5.2		9.0	5.2		8.9	62/205r		20.0	
22.0	8.4	5.2	3.6	8.4	5.2	3.7	8.2	5.2	3.7	8.1	5.2	3.7	8.0	5.2	37/223m	7.9	5.2	37/229m	7.8	5.2	37/234r	7.7	5.2	37/239r	7.5	5.2		22.0	
24.0	7.4	4.9	3.3	7.3	5.1	3.4	7.1	5.2	3.5	7.0	5.2	3.6	6.9	5.2	3.6	6.8	5.2	3.7	6.7	5.2	3.7	6.5	5.2	3.7	6.4	5.2	37/244m	24.0	
26.0	6.5	4.6	3.1	6.4	4.8	3.2	6.2	4.9	3.3	6.1	5.1	3.3	6.0	5.2	3.4	5.8	5.2	3.5	5.7	5.2	3.5	5.6	5.2	3.6	5.5	5.2	3.6	26.0	
28.0	5.7	4.2	2.9	5.6	4.5	3.0	5.4	4.7	3.1	5.3	4.8	3.1	5.2	4.9	3.2	5.1	5.1	3.3	4.9	5.2	3.3	4.8	5.2	3.4	4.7	5.2	3.5	28.0	
30.0	5.1	4.0	2.7	4.9	4.2	2.8	4.8	4.5	2.9	4.7	4.6	3.0	4.5	4.7	3.0	4.4	4.8	3.1	4.3	4.7	3.2	4.1	4.6	3.2	4.0	4.5	3.3	30.0	
32.0	4.5	3.8	2.5	4.4	4.0	2.6	4.2	4.1	2.7	4.1	4.2	2.8	4.0	4.4	2.9	3.8	4.2	2.9	3.7	4.1	3.0	3.6	4.0	3.1	3.4	3.9	3.1	32.0	
34.0	4.0	3.7	2.4	3.9	3.8	2.5	3.7	3.9	2.6	3.6	4.0	2.7	3.5	3.8	2.7	3.3	3.7	2.8	3.2	3.6	2.9	3.1	3.5	2.9	2.9	3.4	3.0	34.0	
36.0	3.5	3.5	2.3	3.4	3.7	2.4	3.3	3.6	2.5	3.1	3.5	2.5	3.0	3.4	2.6	2.9	3.3	2.7	2.7	3.1	2.7	2.6	3.0	2.8	2.5	2.9	2.9	36.0	
38.0		3.4	2.2	3.0	3.3	2.3	2.9	3.2	2.3	2.8	3.1	2.4	2.6	3.0	2.5	2.5	2.8	2.6	2.3	2.7	2.6	2.2	2.6	2.7	2.0	2.5	2.7	38.0	
40.0		3.1	2.1		3.0	2.2	2.5	2.8	2.2	2.4	2.7	2.3	2.3	2.6	2.4	2.1	2.5	2.4	2.0	2.4	2.5	1.8	2.2	2.5	1.5	2.1	2.4	40.0	
42.0			2.7	2.0		2.6	2.1		2.5	2.1	2.1	2.4	2.2	2.0	2.3	2.3	1.8	2.1	2.3	1.6	2.0	2.3		1.9	2.2		1.8	2.0	42.0
44.0			1.9		2.3	2.0		2.2	2.0	1.8	2.1	2.1	1.7	2.0	2.2		1.8	2.1		1.7	2.0		1.6	1.9			1.7	44.0	
46.0			1.8		1.9		1.9	1.9		1.8	2.0		1.7	1.9			1.6	1.8			1.7			1.6					46.0
48.0			1.7		1.8		1.8	1.8		1.8	1.8		1.6	1.8			1.5												48.0
50.0					1.7		1.6	1.6		1.5																			50.0

※表中の太線で囲まれた部分は、ブーム等の強度によって定められた値です。

▶ジブ定格総荷重表 (主ブームにフックなし/ジブオフセット角度10°)

ジブ長さ(m) 吊钩位置 標高(m)	29.1			32.1			35.2			38.2			41.2			44.3			47.3			50.4			53.4			ジブ長さ(m) 吊钩位置 標高(m)
	9.1	15.2	21.3	9.1	15.2	21.3	9.1	15.2	21.3	9.1	15.2	21.3	9.1	15.2	21.3	9.1	15.2	21.3	9.1	15.2	21.3	9.1	15.2	21.3	9.1	15.2	21.3	
9.0	11.0																										9.0	
10.0	11.0	9.1/11.7m		11.0/12.7m			11.0/12.7m			11.0/12.7m			11.0/12.7m														10.0	
12.0	11.0	9.1	7.2/13.6m	11.0	9.1/12.3m		11.0	9.1/12.5m		11.0	9.1/12.5m		11.0	9.1/13.5m		11.0/12.3m			11.0/12.3m		11.0/12.3m		11.0/13.3m		11.0/13.3m		12.0	
14.0	11.0	9.1	7.0	11.0	9.1	7.1/14.3m	11.0	9.1	7.1/14.6m	11.0	9.1	7.2/15.4m	11.0	9.1	7.2/15.9m	11.0	9.1	7.1/14.4m		11.0	9.1/14.9m		11.0	9.1/15.4m		11.0/13.3m	14.0	
16.0	11.0	9.1	6.9	11.0	9.1	6.9	11.0	9.1	7.0	11.0	9.1	7.0	11.0	9.1	7.0	11.0	9.1	7.1/15.4m	11.0	9.1	7.1/17.0m	11.0	9.1	7.1/17.5m	11.0	9.1	16.0	
18.0	11.0	9.1	6.7	11.0	9.1	6.7	11.0	9.1	6.8	11.0	9.1	6.8	11.0	9.1	6.9	11.0	9.1	6.9	11.0	9.1	7.0	11.0	9.1	7.0	11.0	9.1	7.0	18.0
20.0	10.5	9.1	6.5	10.3	9.1	6.6	10.2	9.1	6.6	10.0	9.1	6.7	9.9	9.1	6.7	9.7	9.1	6.8	9.6	9.1	6.8	9.6	9.1	6.8	9.5	9.1	6.9	20.0
22.0	9.2	8.9	6.3	9.0	9.1	6.4	8.9	9.1	6.5	8.7	8.9	6.5	8.6	8.8	6.6	8.4	8.7	6.6	8.3	8.5	6.7	8.2	8.4	6.7	8.0	8.3	6.8	22.0
24.0	8.1	8.2	6.1	8.0	8.2	6.2	7.8	8.0	6.3	7.7	7.9	6.4	7.5	7.7	6.5	7.4	7.6	6.5	7.2	7.5	6.6	7.1	7.3	6.6	6.9	7.2	6.6	24.0
26.0	7.2	7.4	5.8	7.1	7.3	6.0	6.9	7.1	6.1	6.8	7.0	6.2	6.6	6.8	6.3	6.5	6.7	6.4	6.3	6.6	6.4	6.2	6.4	6.5	6.0	6.3	6.5	26.0
28.0	6.5	6.7	5.4	6.3	6.5	5.7	6.2	6.4	5.9	6.0	6.2	6.0	5.9	6.1	6.1	5.7	5.9	6.2	5.6	5.9	6.1	5.4	5.7	6.0	5.3	5.5	5.8	28.0
30.0	5.9	6.0	5.0	5.7	5.9	5.3	5.5	5.7	5.5	5.4	5.6	5.8	5.3	5.4	5.7	5.1	5.3	5.5	4.9	5.1	5.4	4.8	5.0	5.3	4.6	4.9	5.2	30.0
32.0	5.3	5.5	4.7	5.2	5.3	4.9	5.0	5.2	5.2	4.8	5.0	5.2	4.7	4.9	5.1	4.5	4.7	5.0	4.4	4.6	4.9	4.2	4.4	4.7	4.1	4.3	4.6	32.0
34.0	4.8	5.0	4.4	4.7	4.8	4.6	4.5	4.7	4.9	4.4	4.5	4.8	4.2	4.4	4.6	4.0	4.2	4.5	3.9	4.1	4.4	3.8	3.9	4.2	3.6	3.9	4.1	34.0
36.0		4.6	4.2	4.3	4.4	4.4	4.1	4.2	4.4	3.9	4.1	4.3	3.8	4.0	4.2	3.6	3.8	4.0	3.5	3.7	3.9	3.3	3.5	3.8	3.2	3.3	3.6	36.0
38.0		4.2	3.9		4.0	4.1	3.7	3.9	4.1	3.6	3.7	3.9	3.4	3.6	3.8	3.2	3.4	3.6	3.1	3.3	3.5	2.9	3.1	3.4	2.7	2.9	3.2	38.0
40.0		3.8	3.7		3.7	3.9	3.4	3.5	3.7	3.2	3.4	3.6	3.1	3.2	3.4	2.9	3.1	3.3	2.7	2.9	3.2	2.5	2.8	3.0	2.3	2.5	2.9	40.0
42.0			3.5		3.4	3.6		3.2	3.4	2.9	3.1	3.3	2.8	2.9	3.1	2.6	2.8	3.0	2.4	2.6	2.9	2.2	2.4	2.7	1.9	2.2	2.5	42.0
44.0			3.3		3.3		2.9	3.1		2.8	3.0	2.5	2.7	2.9	2.3	2.5	2.7	2.1	2.3	2.6	1.8	2.1	2.4	1.6	1.8	2.2	44.0	
46.0			3.1		3.0		2.7	2.9		2.6	2.7		2.4	2.6	2.0	2.2	2.4	1.8	2.0	2.3	1.6	1.8	2.1		1.5	1.9	46.0	
48.0					2.8			2.6		2.3	2.5		2.1	2.4	1.7	1.9	2.2	1.5	1.7	2.0		1.5	1.8			1.6	48.0	
50.0								2.4			2.3			1.9	2.1		1.6	1.9			1.7						50.0	
52.0											2.1				1.9			1.7			1.5							52.0
54.0											1.9				1.7						1.5							54.0

※表中の太線で囲まれた部分は、ブーム等の強度によって定められた値です。

▶ジブ定格総荷重表 (主ブームにフックなし/ジブオフセット角度30°)

ジブ長さ(m) 吊钩位置 標高(m)	29.1			32.1			35.2			38.2			41.2			44.3			47.3			50.4			53.4			ジブ長さ(m) 吊钩位置 標高(m)
	9.1	15.2	21.3	9.1	15.2	21.3	9.1	15.2	21.3	9.1	15.2	21.3	9.1	15.2	21.3	9.1	15.2	21.3	9.1	15.2	21.3	9.1	15.2	21.3	9.1	15.2	21.3	
12.0	9.5/12.4m			9.5/12.3m			9.5/13.4m																				12.0	
14.0	9.5			9.5			9.5					9.5/14.5m			9.5/15.0m			9.5/15.5m									14.0	
16.0	9.5	9.5/16.3m		9.5	9.5/16.6m		9.5	9.5/17.4m		9.5	9.5/17.5m		9.5		9.5			9.5			9.5/18.1m			9.5/18.6m			16.0	
18.0	9.5	9.5		9.5	9.5		9.5	9.5		9.5	9.5		9.5	9.5/18.4m		9.5	9.5/18.9m		9.5	9.5/19.5m		9.5		9.5			18.0	
20.0	9.5	9.5	3.7/20.3m	9.5	9.5	3.7/20.7m	9.5	9.5	3.7/21.3m	9.5	9.5	3.7/21.9m	9.5	9.5		9.5	9.5		9.5	9.5		9.5	9.5		9.5	9.5/20.5m	20.0	
22.0	9.3	9.5	3.7	9.3	9.5	3.7	9.1	9.5	3.7	9.0	9.5	3.7	8.9	9.5	3.7/22.3m	8.8	9.5	3.7/22.9m	8.7	9.5	3.7/23.5m	8.6	9.5	3.7/23.9m	8.4	9.5	22.0	
24.0	8.3	9.5	3.7	8.2	9.5	3.7	8.0	9.5	3.7	7.9	9.5	3.7	7.8	9.5	3.7	7.7	9.5	3.7	7.6	9.5	3.7	7.4	9.5	3.7	7.3	9.5	3.7/24.4m	24.0
26.0	7.4	9.5	3.7	7.3	9.5	3.7	7.1	9.5	3.7	7.0	9.5	3.7	6.9	9.5	3.7	6.7	9.5	3.7	6.6	9.5	3.7	6.5	9.5	3.7	6.4	9.5	3.7	26.0
28.0	6.6	9.5	3.7	6.5	9.5	3.7	6.3	9.5	3.7	6.2	9.5	3.7	6.1	9.5	3.7	6.0	9.5	3.7	5.8	9.5	3.7	5.7	9.5	3.7	5.6	9.5	3.7	28.0
30.0	6.0	9.5	3.6	5.8	9.5	3.7	5.7	9.5	3.7	5.6	9.5	3.7	5.4	9.5	3.7	5.3	9.5	3.7	5.2	9.5	3.7	5.0	9.5	3.7	4.9	9.5	3.7	30.0
32.0	5.4	9.5	3.4	5.3	9.5	3.5	5.1	9.5	3.6	5.0	9.5	3.7	4.9	9.5	3.7	4.7	9.5	3.7	4.6	9.5	3.7	4.5	9.5	3.7	4.3	9.5	3.7	32.0
34.0	4.9	9.5	3.3	4.8	9.5	3.4	4.6	9.5	3.5	4.5	9.5	3.6	4.4	9.5	3.6	4.2	9.5	3.7	4.1	9.5	3.7	4.0	9.5	3.7	3.8	9.5	3.7	34.0
36.0	4.4	9.5	3.2	4.3	9.5	3.3	4.2	9.5	3.4	4.0	9.5	3.4	3.9	9.5	3.3	3.8	9.5	3.6	3.6	9.5	3.6	3.5	9.5	3.6	3.4	9.5	3.6	36.0
38.0		4.3	3.1	3.9	4.2	3.2	3.8	4.1	3.2	3.7	4.0	3.3	3.5	3.9	3.4	3.4	3.7	3.5	3.2	3.6	3.5	3.1	3.5	3.6	2.9	3.4	3.6	38.0
40.0		4.0	3.0		3.9	3.1	3.4	3.7	3.1	3.3	3.6	3.2	3.2	3.5	3.3	3.0	3.4	3.3	2.9	3.3	3.4	2.7	3.1	3.4	2.5	3.0	3.3	40.0
42.0		3.6	2.9		3.5	3.0		3.4	3.0	3.0	3.3	3.1	2.9	3.2	3.2	2.7	3.0	3.2	2.5	2.9	3.2	2.3	2.8	3.1	2.1	2.7	2.9	42.0
44.0			2.8		3.2	2.9		3.1	2.9	2.7	3.0	3.0	2.6	2.9	3.1	2.3	2.7	3.0	2.2	2.6	2.9	2.0	2.5	2.8	1.8	2.3	2.6	44.0
46.0			2.7		2.8		2.8	2.8		2.7	2.9	2.8	2.7	2.9	2.8	2.0	2.5	2.7	1.9	2.3	2.6	1.7	2.1	2.5		2.0	2.3	46.0
48.0			2.6		2.7			2.7		2.5	2.7		2.3	2.5	1.8	2.2	2.4	1.6	2.0	2.3		1.8	2.2		1.6	2.0	48.0	
50.0					2.6			2.5		2.2	2.4		2.1	2.3		1.9	2.2		1.7	2.0		1.6	1.9			1.7	50.0	
52.0								2.3			2.2			1.8	2.1		1.6	1.9		1.5	1.7			1.6			52.0	
54.0											2.0				1.8			1.6			1.5						54.0	
56.0											1.7				1.6													56.0

※表中の太線で囲まれた部分は、ブーム等の強度によって定められた値です。

# ラッピングタワー

▶全体図(単位: mm)

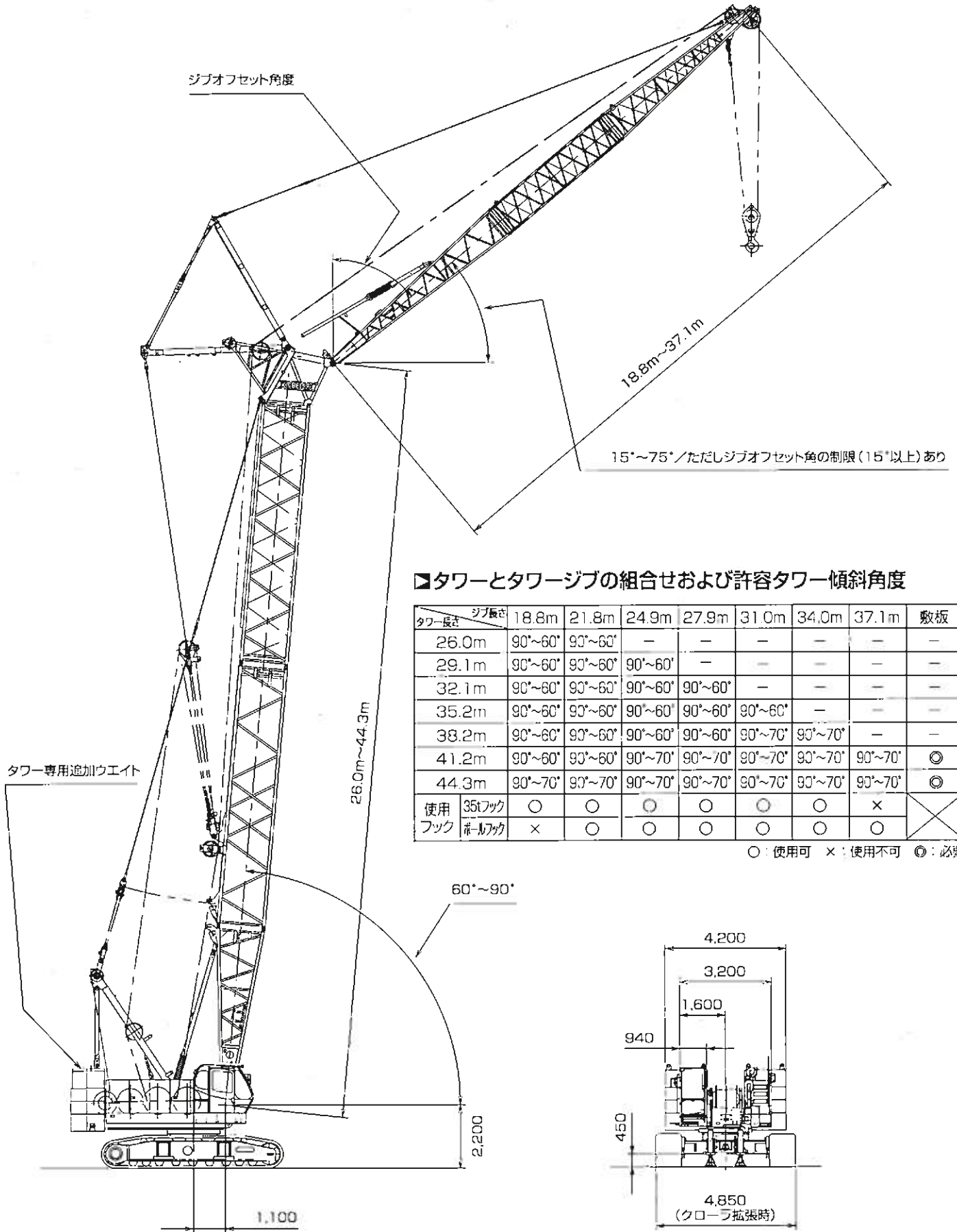

▶タワーとタワージブの組合せおよび許容タワー傾斜角度

タワー長さ	ジブ長さ	18.8m	21.8m	24.9m	27.9m	31.0m	34.0m	37.1m	敷板
26.0m		90°~60°	90°~60°	—	—	—	—	—	—
29.1m		90°~60°	90°~60°	90°~60°	—	—	—	—	—
32.1m		90°~60°	90°~60°	90°~60°	90°~60°	—	—	—	—
35.2m		90°~60°	90°~60°	90°~60°	90°~60°	90°~60°	—	—	—
38.2m		90°~60°	90°~60°	90°~60°	90°~60°	90°~70°	90°~70°	—	—
41.2m		90°~60°	90°~60°	90°~70°	90°~70°	90°~70°	90°~70°	90°~70°	◎
44.3m		90°~70°	90°~70°	90°~70°	90°~70°	90°~70°	90°~70°	90°~70°	◎
使用	35tフック	○	○	○	○	○	○	○	×
フック	ホムアック	×	○	○	○	○	○	○	×

○: 使用可 ×: 使用不可 ◎: 必費

## ▶タワー構成

- ※印は、これより短いタワーの組立可能な構成を示します。
- 9.1Bは、タワー用ですがクレーンにも転用できます。
- 図の9.1は、9.1mラグ付中間タワー（9.1A）を使用することも可能です。
- 使用するガイラインの径はφ30mm及びφ34mmです。

## ▶タワージブ構成

- ※印は、これより短いタワージブの組立可能な構成を示します。
- 印は、ケーブルローラ取付位置を示します。
- 使用するガイラインの径はφ30mmです。

中間タワーの種類		
記号	タワー長さ	仕様
3.0	3.0m	クレーンおよびタワー共用
6.1	6.1m	クレーンおよびタワー共用
9.1	9.1m	クレーンおよびタワー共用
9.1B	9.1m	タワー専用 (クレーンに兼用可能)
9.1A	9.1m	ラグ付

中間タワージブの種類		
記号	タワージブ長さ	仕様
3.0	3.0m	
5.1T	5.1m	中継ジブ (デーバジブ)
6.1	6.1m	
9.1	9.1m	

タワー長さ m (ft.)	タワー構成
26.0 (85)	
29.1 (95)	※
32.1 (105)	※
	※
35.2 (115)	※
	※
38.2 (125)	※
	※
41.2 (135)	※
	※
44.3 (145)	※

タワー長さ m (ft.)	タワージブ構成
18.8 (62)	
21.8 (72)	※
24.9 (82)	※
	※
27.9 (92)	※
	※
31.0 (102)	※
	※
34.0 (112)	※
	※
37.1 (122)	※

## ▶ 定格総荷重

- 定格総荷重とは、水平堅土上における転倒荷重の78%以内で、フックブロック、玉掛用ワイヤロープ等のつり具の質量を含んだ値です。
- 作業半径とはクレーン旋回中心よりつり上荷重の重心までの水平距離を意味します。
- 実際につり上げ得る荷重は定格総荷重から（主フック+玉掛用ワイヤロープ等のつり具）の質量を差し引いた値になります。
- 定格総荷重をつる場合にも風の影響、地盤の状態、作業速度その他安全作業に有害な状況がある時はオペレータは荷重の軽減、作業速度を遅くするなど状況に応じた判断をする責任があります。
- 表中の空欄の個所では作業を行うことができません。
- クレーン作業中はガントリを最高位置に立ててください。
- ラフティングタワー作業時には、タワー専用追加カウンタウエイト（1.6t）が必要です。

- すべてのタワー（ジブ）長さにおける中間タワーブーム（ジブ）の構成は取扱説明書の指示を厳守してください。
  - ジブ長さ18.8mには11tボールフックの使用はできません。
  - 下記の仕様ではタワー自立および降下の際にクローラの前端に敷板（ブロック）を敷いてください。  
※タワー長さ 41.2m（135）および44.3m（145）
- △ 操作ミスなどによるつり荷の落下を防ぐため、クレーン作業では自由降下（フリーフォール）作業は行わないでください。

- 巻上げロープ巻掛本数に対する最大巻上荷重とフックの質量

フック呼称		35t	11t ボールフック
最大巻上 荷重 (t)	1本掛	11.0	11.0
	2本掛	15.0	-
フック質量		0.70t	0.30t

# ▶タワー長さ 26.0m

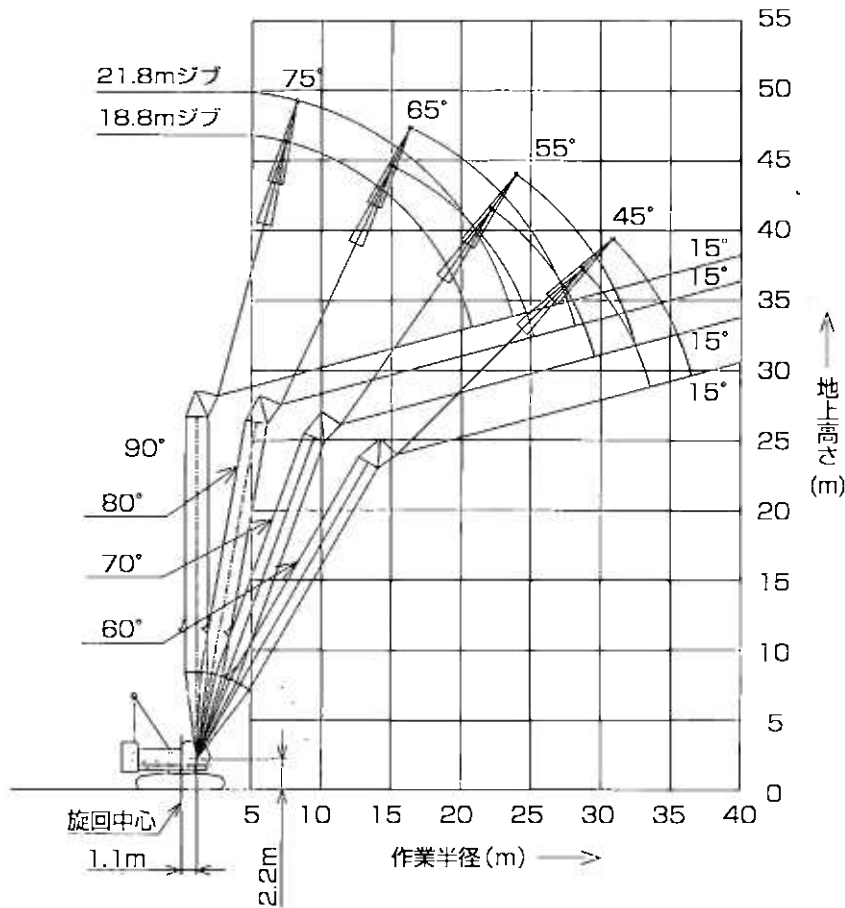

(単位:t)

タワー長さm		26.0								タワー長さm
ジブ長さm		18.8				21.8				ジブ長さm
タワー角度	90°	80°	70°	60°	90°	80°	70°	60°	タワー角度	
作業半径 (m)	7.7	15.0							7.7	
	8.0	15.0			15.0/8.5m				8.0	
	9.0	15.0			15.0				9.0	
	10.0	15.0			15.0				10.0	
	12.0	15.0			15.0				12.0	
	14.0	15.0	15.0/15.2m		15.0				14.0	
	16.0	13.7	14.9		13.7	14.2/16.5m			16.0	
	18.0	11.9	12.9		11.8	12.8			18.0	
	20.0	10.6	11.4		10.4	11.2			20.0	
	22.0	9.3/20.5m	10.1	8.8/22.3m	9.2	10.0			22.0	
	24.0		9.1	8.0	7.8/23.4m	9.0	7.9		24.0	
	26.0		8.5/24.9m	7.4		8.1	7.2		26.0	
	28.0			6.7	5.6/28.7m	7.4/27.9m	6.6		28.0	
	30.0			6.2/29.3m	5.4		6.1	5.0/30.8m	30.0	
	32.0				5.0		5.6	4.8	32.0	
	34.0				4.7/33.3m		5.5/32.2m	4.5	34.0	
	36.0							4.2	36.0	
38.0							4.1/36.2m	38.0		

※表中の太線で囲まれた部分は、ブーム等の強度によって定められた値です。

# ▶タワー長さ 29.1m

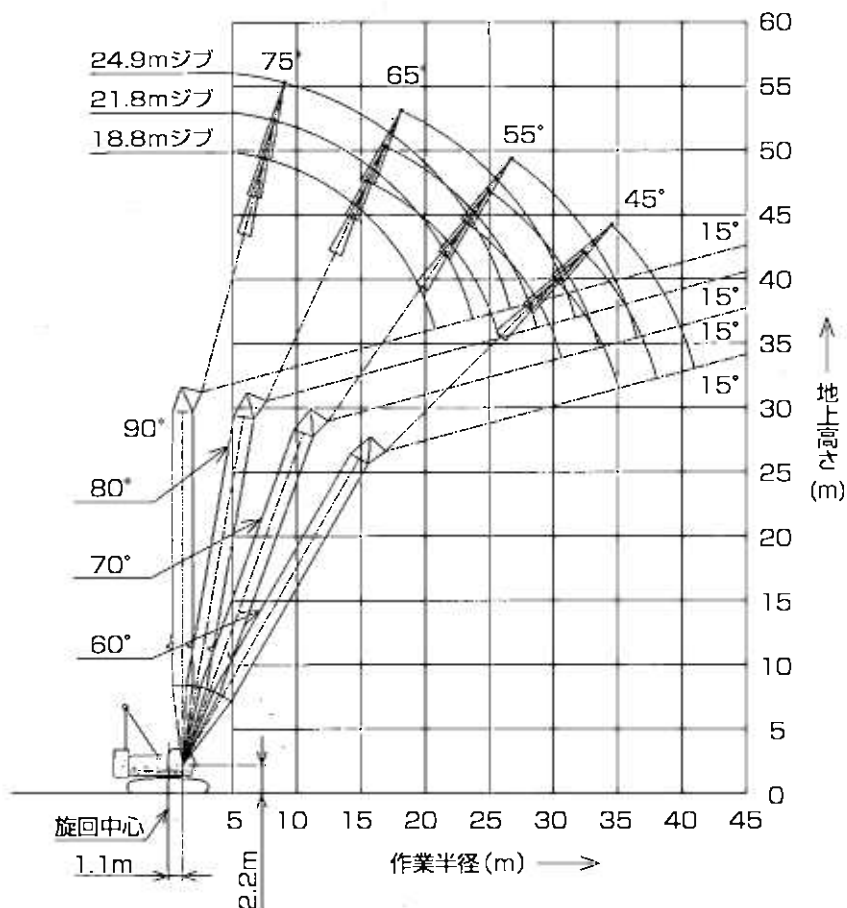

(単位:t)

タワー長さm	29.1												タワー長さm	
ジブ長さm	18.8				21.8				24.9				ジブ長さm	
タワー角度	90°	80°	70°	60°	90°	80°	70°	60°	90°	80°	70°	60°	タワー角度	
作業半径 (m)	7.7	15.0											7.7	
	8.0	15.0			15.0/8.5m								8.0	
	9.0	15.0			15.0				15.0/9.3m				9.0	
	10.0	15.0			15.0				15.0				10.0	
	12.0	15.0			15.0				15.0				12.0	
	14.0	15.0	14.9/15.7m		15.0				15.0				14.0	
	16.0	13.7	14.7		13.7	13.4/17.0m			13.6				16.0	
	18.0	11.9	12.7		11.8	12.6			11.8	12.1/18.3m			18.0	
	20.0	10.4	11.2		10.4	11.0			10.3	10.9			20.0	
	22.0	9.4/20.5m	9.9	7.9/23.3m		9.2	9.8		9.2	9.8			22.0	
	24.0		8.9	7.7		8.0/23.4m	8.8	7.1/25.0m		8.3	8.8		24.0	
	26.0		8.1/25.5m	7.1			8.0	6.8		7.5	8.0	6.4/26.8m	26.0	
	28.0			6.4			7.3	6.3		6.9/26.3m	7.3	6.1	28.0	
	30.0			5.9	4.9/30.2m		7.0/28.4m	5.8			6.7	5.7	30.0	
	32.0			5.7/30.3m	4.6			5.3	4.3/32.3m		6.1/31.4m	5.3	32.0	
	34.0				4.3			5.0/33.2m	4.1			4.9	3.9/34.5m	34.0
	36.0				4.1/34.8m				3.9			4.5	3.7	36.0
38.0								3.6/37.7m			4.4/36.2m	3.5	38.0	
40.0												3.3	40.0	
42.0												3.2/40.7m	42.0	

※表中の太線で囲まれた部分は、ブーム等の強度によって定められた値です。

# ▶タワー長さ 32.1m

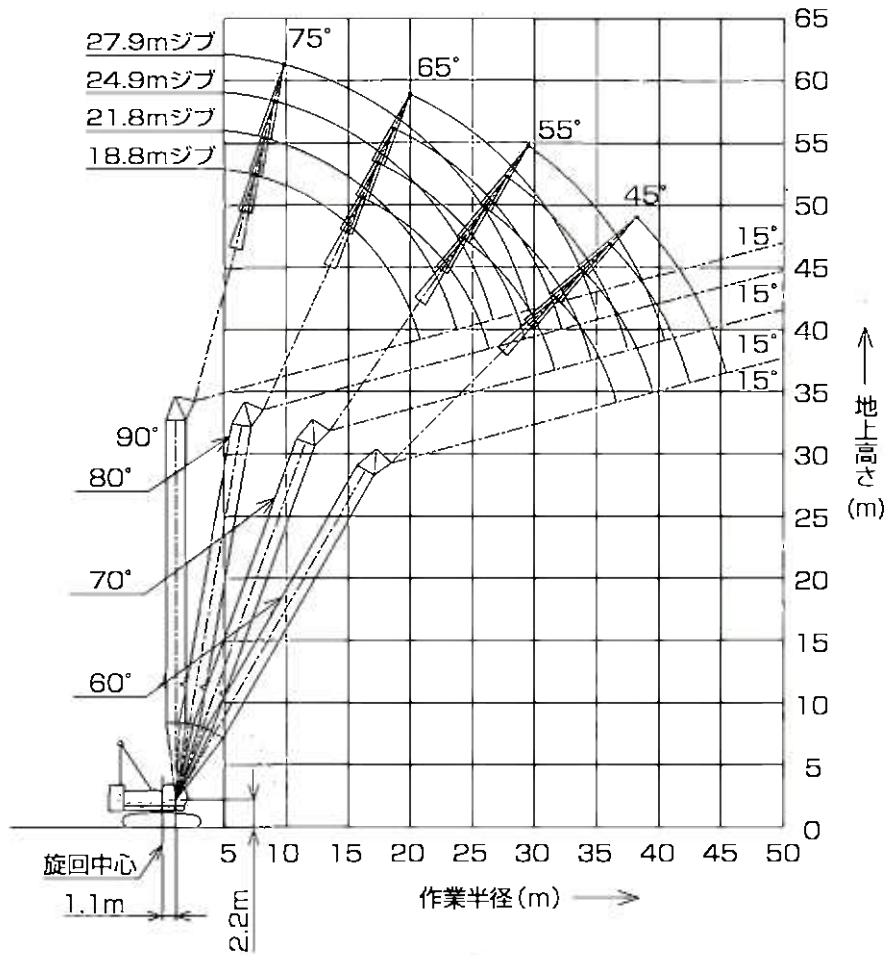

(単位:t)

タワー長さm	32.1																タワー長さm
ジブ長さm	18.8				21.8				24.9				27.9				ジブ長さm
タワー角度	90°	80°	70°	60°	90°	80°	70°	60°	90°	80°	70°	60°	90°	80°	70°	60°	タワー角度
7.7	15.0																7.7
8.0	15.0				15.0/8.5m												8.0
9.0	15.0				15.0				15.0/9.3m								9.0
10.0	15.0				15.0				15.0				15.0/10.1m				10.0
12.0	15.0				15.0				15.0				15.0				12.0
14.0	15.0				15.0				15.0				15.0				14.0
16.0	13.8	14.0/16.3m			13.7	12.6/17.6m			13.7				13.6				16.0
18.0	11.9	12.4			11.9	12.3			11.8	11.5/18.9m			11.7				18.0
20.0	10.4	10.9			10.4	10.8			10.4	10.7			10.3	10.5/20.1m			20.0
22.0	9.6/20.5m	9.7			9.2	9.6			9.2	9.6			9.1	9.4			22.0
24.0		8.7	7.1/24.3m		8.1/23.4m	8.6			8.3	8.7			8.2	8.6			24.0
26.0		7.9	6.6		7.8	6.4/26.1m			7.5	7.8	5.8/27.8m		7.4	7.7			26.0
28.0			6.1		7.1	5.9			7.0/25.3m	7.2	5.8		6.8	7.1	5.3/29.6m		28.0
30.0			5.6	4.3/31.7m		6.7/29.0m	5.5			6.6	5.4		6.0/29.3m	6.5	5.2		30.0
32.0			5.2/31.3m	4.3			5.1	3.7/33.9m		6.0/31.9m	5.0		6.0	4.9			32.0
34.0				3.9			4.7	3.7			4.6			5.5	4.5		34.0
36.0				3.6			4.6/34.3m	3.5			4.3	3.4		5.3/34.8m	4.2		36.0
38.0				3.5/36.3m				3.3			4.0/37.2m	3.2			3.9	3.0/38.2m	38.0
40.0								3.1/39.3m				3.0			3.6	2.9	40.0
42.0												2.8			3.5/40.2m	2.7	42.0
44.0													2.6/42.2m			2.5	44.0
46.0																2.2/45.1m	46.0

※表中の太線で囲まれた部分は、ブーム等の強度によって定められた値です。

# ▶タワー長さ 35.2m

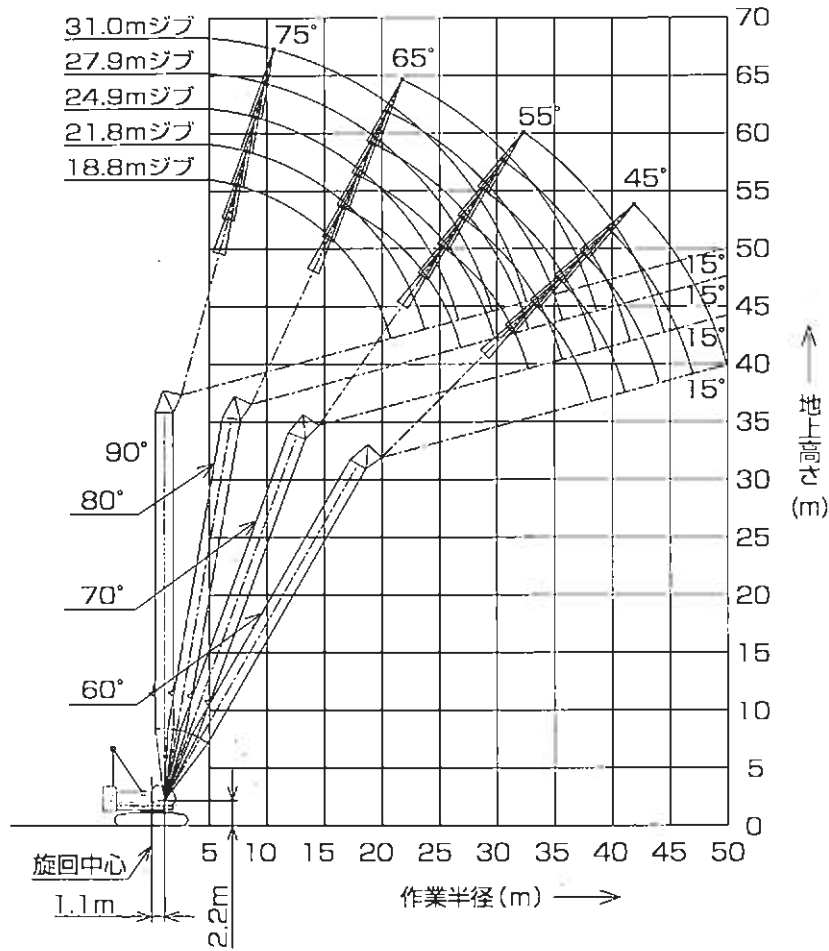

(単位:t)

タワー長さm		35.2																タワー長さm					
ジブ長さm		18.8				21.8				24.9				27.9				31.0				ジブ長さm	
タワー角度		90°	80°	70°	60°	90°	80°	70°	60°	90°	80°	70°	60°	90°	80°	70°	60°	90°	80°	70°	60°	タワー角度	
作業半径 (m)	7.7	15.0																				7.7	
	8.0	15.0				15.0/8.5m																8.0	
	9.0	15.0				15.0				15.0/9.2m												9.0	
	10.0	15.0				15.0				15.0				15.0/10.1m				13.5/10.9m				10.0	
	12.0	15.0				15.0				15.0				15.0				13.5				12.0	
	14.0	15.0				15.0				15.0				15.0				13.5				14.0	
	16.0	13.8	13.2/13.6m			13.7				13.7				13.6				13.5				16.0	
	18.0	11.9	12.2			11.9	12.0/18.1m			11.8	10.9/19.4m			11.7				11.7				18.0	
	20.0	10.4	10.7			10.4	10.6			10.4	10.5			10.3	9.9/20.7m			10.2				20.0	
	22.0	9.6/20.5m	9.6			9.3	9.6			9.2	9.5			9.2	9.2			9.1	9.1			22.0	
	24.0		8.6	8.5/23.4m		8.2/23.4m	8.6			8.3	8.5			8.2	8.4			8.2	8.2			24.0	
	26.0		7.8	6.3			7.8	5.8/27.1m		7.5	7.7			7.4	7.6			7.4	7.5			26.0	
	28.0		7.4/26.5m	5.9			7.1	5.6		7.0/26.3m	7.0	5.3/26.9m		6.8	6.9			6.7	6.9			28.0	
	30.0			5.4			6.4/29.3m	5.3			6.4	5.1		6.0/29.3m	6.3	4.8/30.6m		6.2	6.3			30.0	
	32.0			4.9	3.6/33.2m			4.8			5.9	4.8			5.8	4.5		5.7	5.8	4.3/32.4m		32.0 (m)	
	34.0			4.8/32.4m	3.6			4.5	3.2/35.4m		5.7/32.4m	4.4			5.4	4.3		5.3/32.2m	5.3	4.1		34.0	
	36.0				3.4			4.2/35.3m	3.2			4.1	2.9/37.5m		5.0/35.4m	4.0			5.0	3.9		36.0	
	38.0					3.1/37.8m			3.0			3.8	2.9			3.7	2.5/39.7m		4.6	3.6		38.0	
	40.0								2.8			3.7/38.3m	2.7			3.4	2.5		4.5/38.3m	3.4	2.1/41.9m		40.0
	42.0									2.6/40.6m			2.5				3.2/41.2m	2.3		3.1	2.1	42.0	
44.0												2.3/43.7m					2.1		2.9	1.9	44.0		
46.0																	1.9			2.9/41.2m	1.8	46.0	
48.0																		1.8/46.7m			1.7	48.0	

※表中の太線で囲まれた部分は、ブーム等の強度によって定められた値です。

# ▶タワー長さ 38.2m

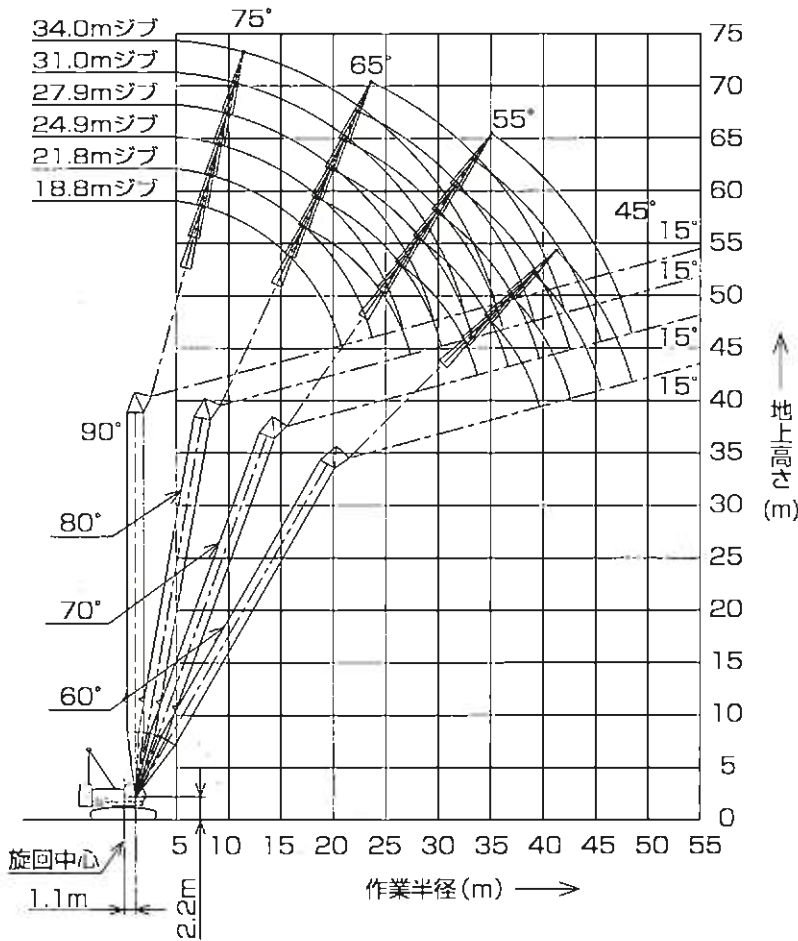

(単位:t)

タワー長さm	38.2				タワー長さm
ジブ長さm	18.8				ジブ長さm
タワー角度	90°	80°	70°	60°	タワー角度
7.7	15.0				7.7
8.0	15.0				8.0
9.0	15.0				9.0
10.0	15.0				10.0
12.0	15.0				12.0
14.0	15.0				14.0
16.0	13.8	12.5/17.3m			16.0
18.0	11.9	12.0			18.0
20.0	10.5	10.5			20.0
22.0	9.7/20.5m	9.3			22.0
24.0		8.4			24.0
26.0		7.6	5.8/26.4m		26.0
28.0		7.1/27.1m	5.4		28.0
30.0			5.1		30.0
32.0			4.7		32.0
34.0			4.3/33.4m	3.0/34.8m	34.0
36.0				2.9	36.0
38.0				2.7	38.0
40.0				2.4/33.4m	40.0
42.0					42.0
44.0					44.0
46.0					46.0
48.0					48.0
50.0					50.0

(単位:t)

タワー長さm	38.2															タワー長さm						
ジブ長さm	21.8				24.9				27.9				31.0			34.0				ジブ長さm		
タワー角度	90°	80°	70°	60°	90°	80°	70°	60°	90°	80°	70°	60°	90°	80°	70°	90°	80°	70°	タワー角度			
7.7																			7.7			
8.0	15.0/8.5m																		8.0			
9.0	15.0				15.0/9.3m														9.0			
10.0	15.0				15.0				15.0/10.1m							13.5/10.9m		11.5/11.7m	10.0			
12.0	15.0				15.0				15.0							13.5		11.5	12.0			
14.0	15.0				15.0				15.0							13.5		11.5	14.0			
16.0	13.8				13.7				13.6							13.5		11.5	16.0			
18.0	11.9	11.3/19.3m			11.8	10.3/19.9m			11.8							11.7		11.5	18.0			
20.0	10.4	10.4			10.4	10.3			10.3	9.4/21.2m						10.3		10.2	20.0			
22.0	9.3	9.3			9.2	9.2			9.2	9.0						9.1	8.6/22.3m	9.1	7.9/23.8m	22.0		
24.0	8.2/23.4m	8.4			8.3	8.3			8.2	8.2						8.2	8.0	8.1	7.9	24.0		
26.0		7.6			7.5	7.5			7.4	7.4						7.4	7.3	7.3	7.2	26.0		
28.0		6.9	5.2/28.2m		7.1/26.3m	6.9	4.8/29.9m		6.8	6.8						6.7	6.7	6.7	6.6	28.0		
30.0		6.3	4.8			6.3	4.8		6.1/29.3m	6.2	4.4/31.7m					6.2	6.1	6.1	6.0	30.0		
32.0			4.6			5.8	4.4			5.7	4.3					5.7	5.6	4.0/33.4m	5.6	5.6	32.0	
34.0			4.2			5.5/33.0m	4.1			5.3	4.0					5.6/32.2m	5.2	3.9	5.2	5.1	3.6/35.2m	34.0
36.0			3.9	2.5/36.9m			3.8			4.9/35.9m	3.7					4.8	3.6	4.6/35.2m	4.8	3.5	36.0	
38.0			3.8/36.4m	2.5			3.5	2.2/39.1m			3.4					4.5	3.4		4.4	3.3	38.0	
40.0				2.3			3.3/39.3m	2.2			3.2	1.8/41.2m				4.3/38.8m	3.1		4.1	3.0	40.0	
42.0				2.1				2.0			3.0	1.8					2.9		3.8/41.8m	2.8	42.0	
44.0				1.9/42.3m				1.8			2.9/42.3m	1.5					2.7			2.6	44.0	
46.0								1.5/45.2m									2.5/45.2m			2.5	46.0	
48.0																				2.3	48.0	
50.0																				2.2/48.2m	50.0	

※表中の太線で囲まれた部分は、ブーム等の強度によって定められた値です。

# ▶タワー長さ 41.2m

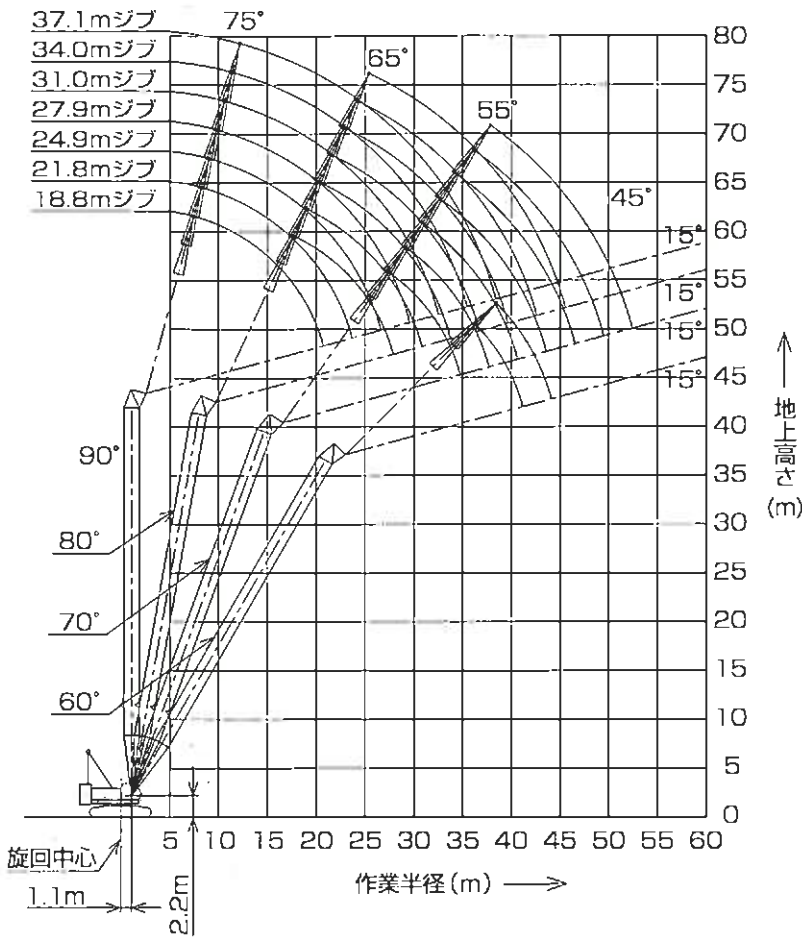

(単位:t)

タワー長さm	41.2				タワー長さm
ジブ長さm	18.8				ジブ長さm
タワー角度	90°	80°	70°	60°	タワー角度
7.7	15.0				7.7
8.0	15.0				8.0
9.0	15.0				9.0
10.0	15.0				10.0
12.0	15.0				12.0
14.0	15.0				14.0
16.0	13.8	11.8/17.9m			16.0
18.0	11.9	11.7			18.0
20.0	10.5	10.3			20.0
22.0	9.8/20.5m	9.1			22.0
24.0		8.2			24.0
26.0		7.4	5.4/27.5m		26.0
28.0		6.7/27.6m	5.2		28.0
30.0			4.8		30.0
32.0			4.4		32.0
34.0			4.1		34.0
36.0			3.9/34.5m	2.4/36.3m	36.0
38.0				2.3	38.0
40.0				2.1	40.0
42.0				1.9/40.9m	42.0
44.0					44.0
46.0					46.0
48.0					48.0
50.0					50.0

(単位:t)

タワー長さm	41.2																		タワー長さm		
ジブ長さm	21.8				24.9			27.9			31.0			34.0			37.1			ジブ長さm	
タワー角度	90°	80°	70°	60°	90°	80°	70°	90°	80°	70°	90°	80°	70°	90°	80°	70°	90°	80°	70°	タワー角度	
7.7																				7.7	
8.0	15.0/8.5m																			8.0	
9.0	15.0				15.0/9.3m															9.0	
10.0	15.0				15.0			15.0/10.1m			13.5/10.9m			11.5/11.7m						10.0	
12.0	15.0				15.0			15.0			13.5			11.5			9.5/12.5m			12.0	
14.0	15.0				15.0			15.0			13.5			11.5			9.5			14.0	
16.0	13.8				13.7			13.6			13.5			11.5			9.5			16.0	
18.0	11.9	10.7/19.2m			11.8			11.8			11.7			11.5			9.4			18.0	
20.0	10.4	10.2			10.4	9.7/20.4m		10.3	9.9/21.7m		10.3			10.2			9.1			20.0	
22.0	9.3	9.1			9.2	8.9		9.2	8.8		9.1	8.2/23.0m		9.1			8.7			22.0	
24.0	8.3/23.4m	8.2			8.3	8.1		8.2	8.0		8.2	7.8		8.1	7.5/24.3m		8.2	7.1/25.3m		24.0	
26.0		7.4			7.5	7.4		7.4	7.3		7.4	7.2		7.3	6.9		7.4	7.0		26.0	
28.0		6.8	4.9/29.2m		7.1/26.3m	6.7		6.8	6.6		6.7	6.5		6.7	6.4		6.7	6.3		28.0	
30.0		6.2	4.7		6.2	4.4/31.0m	6.1/29.3m	6.1		6.2	6.0			6.1	5.9		6.2	5.8		30.0	
32.0		6.0/30.5m	4.3		5.7	4.2		5.6	4.0/32.7m	5.7	5.5			5.6	5.4		5.7	5.3		32.0	
34.0		4.0			5.2/33.5m	3.9		5.1	3.8	5.6/32.2m	5.1	3.6/34.5m		5.2	5.0		5.2	4.9		34.0	
36.0		3.7				3.6		4.8	3.5		4.7	3.4		4.6/35.2m	4.6	3.3/36.2m	4.9	4.5		36.0	
38.0			3.4/37.4m	2.0/38.4m		3.3		4.6/36.4m	3.2		4.4	3.1			4.3	3.0	4.5	4.2	2.9/33.4m	38.0	
40.0				1.9				3.1			3.0			4.1/39.4m	2.9		4.4/38.1m	3.9	2.7	40.0	
42.0				1.7				3.0/40.4m			2.8				2.7		3.7	2.6		42.0	
44.0					1.6/43.8m					2.5/43.2m				2.5		3.7/42.3m	2.4		3.4	2.2	44.0
46.0														2.3					3.2/45.3m	2.1	46.0
48.0															2.2/46.2m					1.9	48.0
50.0																				1.7	50.0
52.0																				1.6	52.0

※表中の太線で囲まれた部分は、ブーム等の強度によって定められた値です。

# ▶タワー長さ 44.3m

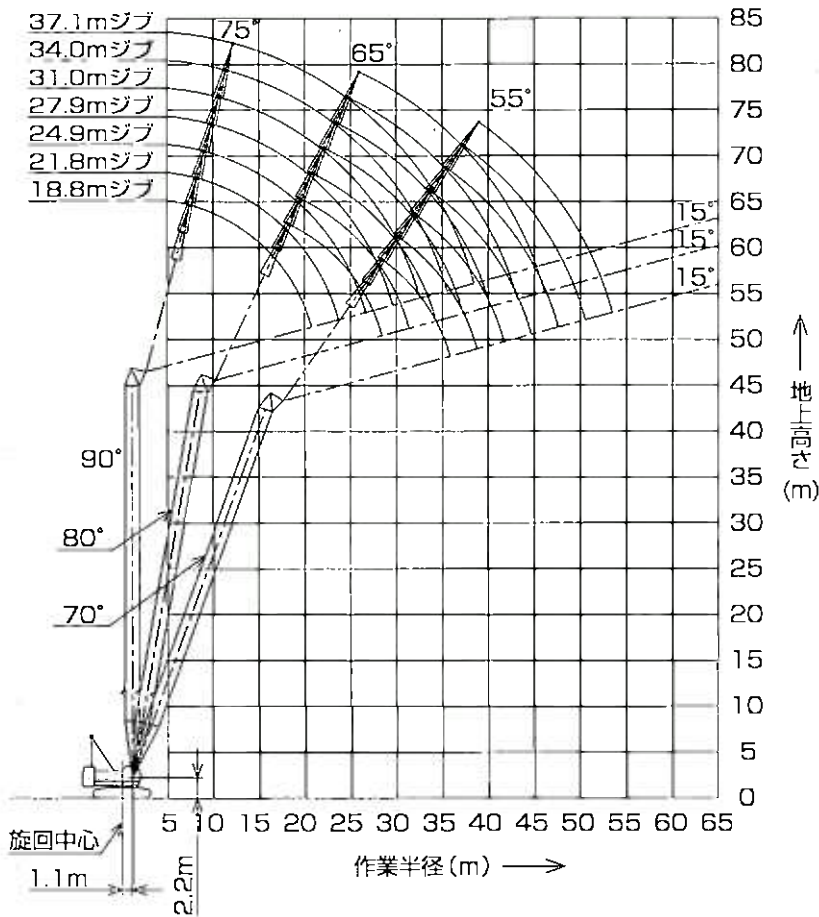

(単位:t)

タワー長さm	44.3			タワー長さm
ジブ長さm	18.8			ジブ長さm
タワー角度	90°	80°	70°	タワー角度
7.7	15.0			7.7
8.0	15.0			8.0
9.0	15.0			9.0
10.0	15.0			10.0
12.0	15.0			12.0
14.0	15.0			14.0
16.0	13.8			16.0
18.0	11.9	11.1/18.4m		18.0
20.0	10.5	10.1		20.0
22.0	9.8/20.5m	9.1		22.0
24.0		8.1		24.0
26.0		7.4		26.0
28.0		6.7	4.8/28.5m	28.0
30.0		6.0/28.1m	4.5	30.0
32.0			4.2	32.0
34.0			3.8	34.0
36.0			3.5/35.5m	36.0
38.0				38.0
40.0				40.0
42.0				42.0
44.0				44.0
46.0				46.0
48.0				48.0
50.0				50.0

(単位:t)

タワー長さm	44.3															タワー長さm				
ジブ長さm	21.8			24.9			27.9			31.0			34.0			37.1			ジブ長さm	
タワー角度	90°	80°	70°	90°	80°	70°	90°	80°	70°	90°	80°	70°	90°	80°	70°	90°	80°	70°	タワー角度	
7.7																				7.7
8.0	15.0/8.5m																			8.0
9.0	15.0			15.0/9.3m																9.0
10.0	15.0			15.0			15.0/10.1m			13.5/10.9m			11.5/11.7m							10.0
12.0	15.0			15.0			15.0			13.5			11.5			9.5/12.5m				12.0
14.0	15.0			15.0			15.0			13.5			11.5			9.5				14.0
16.0	13.8			13.7			13.6			13.5			11.5			9.5				16.0
18.0	11.9	10.1/19.7m		11.9			11.8			11.7			11.5			9.4				18.0
20.0	10.4	9.9		10.4	9.2/21.0m		10.3			10.3			10.2			9.0				20.0
22.0	9.3	8.9		9.2	8.7		9.2	8.4/22.3m		9.1	7.8/23.3m		9.1			8.7				22.0
24.0	8.3/23.4m	8.0		8.3	7.9		8.2	7.7		8.2	7.6		8.1	7.1/24.9m		8.2				24.0
26.0		7.3		7.5	7.2		7.5	7.1		7.4	7.0		7.3	6.7		7.4	6.7/26.5m			26.0
28.0		6.6		7.1/26.3m	6.6		6.8	6.4		6.7	6.4		6.7	6.3		6.7	6.2			28.0
30.0		6.1	4.3/30.3m		6.0		6.1/29.3m	5.9		6.2	5.8		6.1	5.7		6.2	5.6			30.0
32.0		5.7/31.1m	4.0		5.5	3.9		5.4	3.5/33.8m	5.7	5.4		5.6	5.3		5.7	5.2			32.0
34.0			3.7		5.1	3.6		5.0	3.5	5.6/32.2m	5.0	3.2/35.5m	5.2	4.9		5.3	4.8			34.0
36.0			3.4		3.4			4.6	3.2		4.6	3.1	4.7/35.2m	4.5	2.8/37.3m	4.5	4.4			36.0
38.0			3.2		3.1			4.4/37.0m	3.0		4.3	2.9		4.2	2.7	4.5	4.1	2.4/39.4m		38.0
40.0			3.1/38.5m		2.9			2.8		4.0/39.9m	2.7		3.9	2.5	4.4/38.1m	3.8	2.3			40.0
42.0					2.5/41.4m			2.6			2.4		3.6	2.3		3.6	2.1			42.0
44.0								2.3			2.2		3.5/42.9m	2.1		3.3	2.0			44.0
46.0								2.1/44.3m			2.1			2.0		3.1/45.8m	1.8			46.0
48.0											1.8/47.3m					1.8				48.0
50.0																1.6				50.0

※表中の太線で囲まれた部分は、ブーム等の強度によって定められた値です。

## 分解時の寸法・質量

- 記載の数値は参考値です。
- 一般公道での輸送に際しては関係法規を遵守してください。

## 本体

名称	寸法 (幅×高さ×長さ) mm	質量 kg
本体 (下記を含む) ・主巻ロープ 560kg ・補巻ロープ 440kg ・ブーム起伏ロープ 260kg ・燃料1/3 110kg		53,100
本体 (下記を含む、クローラ無し) ・主巻ロープ 560kg ・補巻ロープ 440kg ・ブーム起伏ロープ 260kg ・燃料1/3 110kg		32,700
本体 (下記を含まない) ・クローラ ・ガントリ ・下部スプレッド ・ブーム起伏ロープ		30,800
クローラ	1,025×1,145×6,315	10,200
トランスリフタ	320×960×1,180	350/1基
ガントリ	1,240×865×5,000	1,400
カウンタウエイト 1	4,200×950×1,180	10,000
カウンタウエイト 2	4,200×555×1,180	7,500
カウンタウエイト 3	4,200×555×1,180	7,500
カウンタウエイト 4L	1,440×800×1,130	3,800
カウンタウエイト 4R	1,485×800×1,140	4,000
カウンタウエイト 5L (タワー専用)	1,440×205×1,130	780
カウンタウエイト 5R (タワー専用)	1,485×205×1,140	810

## アタッチメント (ガイドラインの質量は含まれていません)

名称	寸法 (幅×高さ×長さ) mm	質量 kg	名称	寸法 (幅×高さ×長さ) mm	質量 kg
上部ブーム	1,680×1,700×8,320	1,720	5.1m中継ジブ	1,340×1,145×5,160	290
下部ブーム	1,730×2,080×6,370	1,580	3.0m中間タワージブ	1,180×1,145×3,125	180
3.0m中間ブーム	1,670×1,690×3,170	400	6.1m中間タワージブ	1,180×1,145×6,175	320
6.1m中間ブーム	1,670×1,690×6,210	670	9.1m中間タワージブ	1,180×1,145×9,220	460
9.1m中間ブーム	1,670×1,690×9,260	940	タワージブストラット	1,790×915×5,220	1,090
クレーンバックストップ	φ145×4,900 (参考)	130/片側	タワーバックストップ	230×235×5,000	380/片側
上部ジブ	800×800×4,960	280	クレーン上部スプレッド	1,780×305×800	300
下部ジブ	800×800×4,810	200	クレーン下部スプレッド	905×255×710	200
6.1m中間ジブ	800×800×6,160	180	タワージブ起伏用上部スプレッド	780×735×1,175	300
クレーンジブストラット	835×615×3,620	250	タワージブ起伏用下部スプレッド	1,665×465×1,060	370
タワーキャップ	1,705×2,205×3,995	1,220	90tフック	530×1,890×700	1,300
9.1mタワー専用中間ブーム*	1,680×2,505×9,260	1,460	50tフック	430×1,680×700	850
上部タワージブ	1,145×1,145×6,600	560	35tフック	470×1,575×700	700
下部タワージブ	1,685×1,145×7,980	1,060	11tボールフック	φ360×1,050	300

\*上面足場含む

## 標準装備品

●上下部本体
φ26mmウインチ (フリーフォールなし、主巻/補巻)
カウンタウエイト32.8t (10t+7.5t×2+4.0t+3.8t)
900mm幅シュー
136AH/5HRバッテリー
トランスリフタ
トラベルキット
ガントリ起伏シリンダ
電動ハンドスロットル
ブーム速度可変コントローラ
主補速度可変コントローラ
旋回中立フリー/プレーキ切替システム
運転室サイドデッキ
左ガード昇降ステップ
クローラ昇降ステップ×4箇所
アンチスリップシート (ガード上面)
上部スプレッド格納装置
標準工具一式
工具箱 (右ガード内取付)
前照灯×2
バックミラー×2
ドラムミラー×1
ワンウェイコイル
水準器 (カーボディ)
ブームコネクティブホルダー
●運転室
エアコン
ラゲッジボックス
カップキーパ
ラジオ (AM/FM)

灰皿
シガーライター
間欠式ワイパ&ウインドウウォッシャ (天窓/前面/前面下窓)
サンバイザ
天井ブラインド
グリーンガラス
フロアマット:布製
靴置きトレイ
●安全装置
過負荷防止装置 (ブーム緩停止機能付)
過負荷防止装置解除防止キー
過巻防止装置解除防止キー
液晶マルチディスプレイ
第2過巻防止装置 (ブーム角度極限停止機能)
ブーム過巻自動停止装置 (緩停止機能付)
フック過巻自動停止装置
ブームバックストップ
乗降遮断式レバーロック
走行レバーロック
手動式ドラムロック (主巻/補巻)
手動式ドラムロック (ブーム起伏)
中立時ネガブレーキ (主巻/補巻/ブーム起伏/走行)
旋回中立フリー/プレーキ切替表示灯
旋回中立フリー/プレーキ切替スイッチ (ロック機能付)
油圧安全弁 (主巻/補巻/ブーム起伏/走行)
ホーン
マルチボイスアラーム:過巻/過負荷
旋回プレーキロック
旋回ロック (全高4箇所)
旋回フラッシュ/ブザー

## オプション装備品

φ26mmウインチ (フリーフォール付き、主巻/補巻)
中立フリーボイスアラーム (主巻/補巻)
サードドラムワイヤロープφ26×190m、フリーフォール付
リーピングウインチワイヤロープφ8×260m
油圧式タグライン:ワイヤロープφ10×45m
カウンタウエイト吊ワイヤ
自立用敷板
フットアクセセル:case1-右側、case2-左右両側
ブーム起伏ペダル:右側
ドラム回転計/回転感知装置 (主巻/補巻)
キャブ上面ガード
サイドキャットウォーク (手すり付)
ガード上面手すり (折りたたみ式、右ガード梯子付)
ブーム背面全長足場 (アルミ製)

ブーム上面脱着式手すり (スタンションバー)
上部ブーム (タワージブ) 護面保護材
定格総荷重表示板:下部ブーム護面
ブーム看板 (上部ブーム用、中間ブーム用)
後方確認カメラ&モニタ (カラー)
主・補ドラム監視カメラ&モニタ (カラー)
ブームドラム監視カメラ&モニタ (カラー)
過負荷外部表示灯 (角型3色LED)
操程 深度表示装置
警報付風速計
外部音声アラーム:走行/旋回
電動式燃料給油ポンプ
消火器
扇風機

つり上げ荷重5t以上の移動式クレーン運転には「移動式クレーン運転士免許証」、クラムセル作業には「車両系建設機械 (整地ほか) 運転技能講習修了証」、基礎工事には「車両系建設機械 (基礎用) 運転技能講習修了証」がそれぞれ必要です。

## コベルコクレーン株式会社

東京本社 / 〒141-8626 東京都品川区東五反田2-17-1 ☎03-5789-2130  
 北海道 ☎011-377-1902・宮城 ☎0223-24-1482・東京 ☎03-5789-2125  
 市川 ☎047-328-4311・北陸 ☎076-466-3900・東海 ☎052-803-1205  
 近畿 ☎06-6414-2103・中国 ☎082-810-3880・九州 ☎092-503-3329

■お問い合わせは……