

7250-2F

KOBELCO

HYDRAULIC CRAWLER CRANE

7250

Crawler Crane

Max. Lifting Capacity:

250t at 4.6m

Luffing Tower

Max. Lifting Capacity:

25t at 18.0m

Technology and Power, KOBELCO Takes Pride In

Hydraulic Crawler Crane 7250 Now Ready to Launch

Kobelco's hydraulic crawler crane 7250 has taken advantage of new technologies to raise its performance to new heights. Precision and high-elevation crane jobs depend on accuracy and speed, whereas heavy-lifting depends on trustworthy power and strength.

The perfect answer comes in our new 7250. Hoist winches with powerful line-pull are designed to handle the toughest jobs. Large drum capacities combined with a new hydraulic system promote ultra-smooth operation. Excellent transportation features enable cost saving.

Of course, Kobelco is renowned for its engineered technology backed with long and worldwide experience, therefore productivity-boosting technical advances can be found everywhere. With the lifting performance, transportation features, smooth control functions, safety features, also durability and reliability, the 7250 can handle and satisfy all types of crane jobs. Kobelco is proud to announce the new 7250 crawler crane.



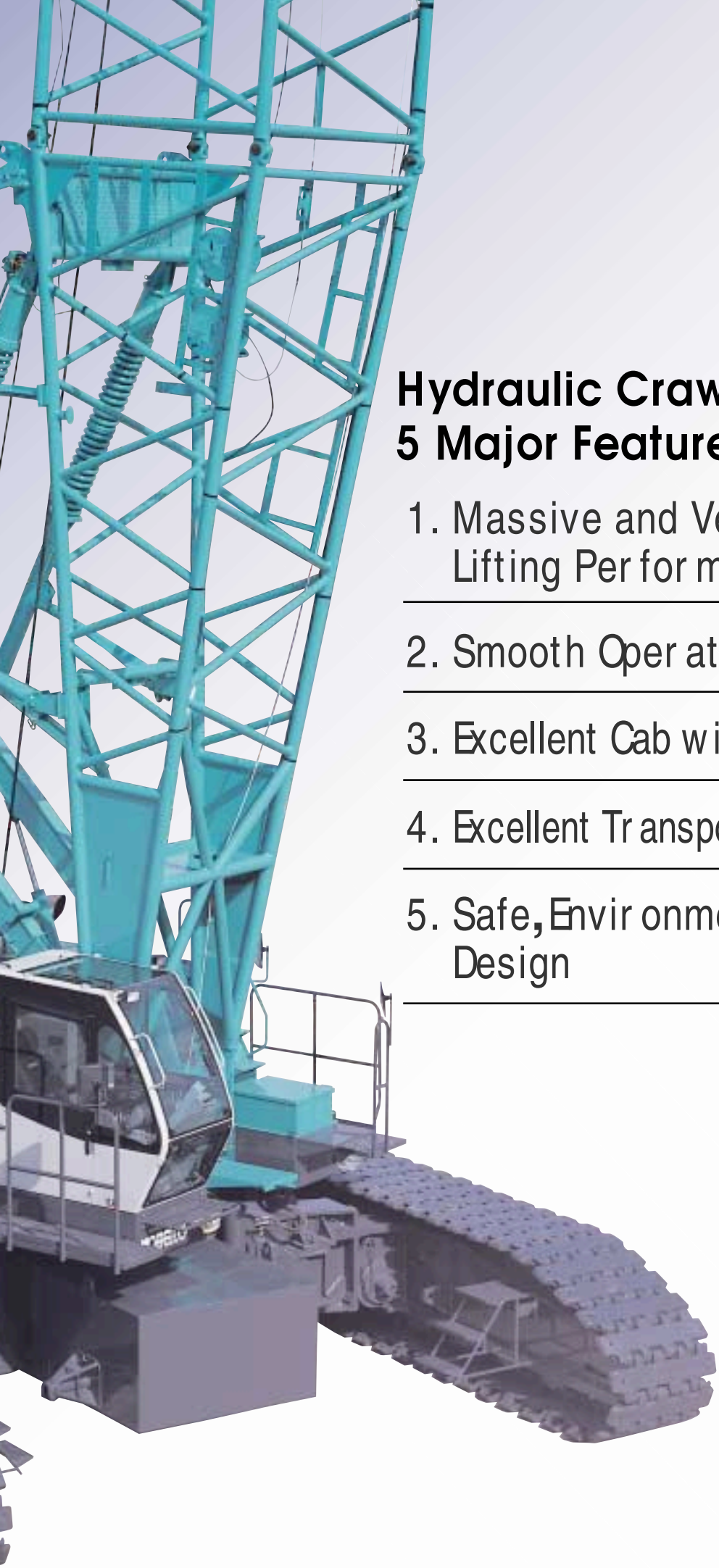

Hydraulic Crawler Crane 7250 5 Major Features

1. Massive and Versatile Lifting Performance

2. Smooth Operation and Control

3. Excellent Cab with Enhanced Functions

4. Excellent Transportability and Assembly

5. Safe, Environmentally-Conscious Design

For both high and heavy lifting

Massive and Versatile Lifting Perf

Large Lifting Capacity

Max. lifting capacity

250t at 4.6m

Max. crane boom length

76.2m

Long Boom Configuration to Achieve Wide Working Ranges

The long boom specification provides a wider operating range with plenty of lifting capacity. The long boom can be made up of insert boom and tower insert jib, to make economic use of attachment components.

Long boom length

73.2m to 91.4m

Lifting capacity at the max. working radius

3.2t at 78.1m

(Using the 88.4m long boom)

Large Working Ranges with Fixed Jib Configuration

The fixed jib specification have allowed work in higher and deeper sites.

Max. combination (crane boom + fixed jib)

76.2m + 30.5m

Lifting capacity at the max working radius

2.4t at 88.0m

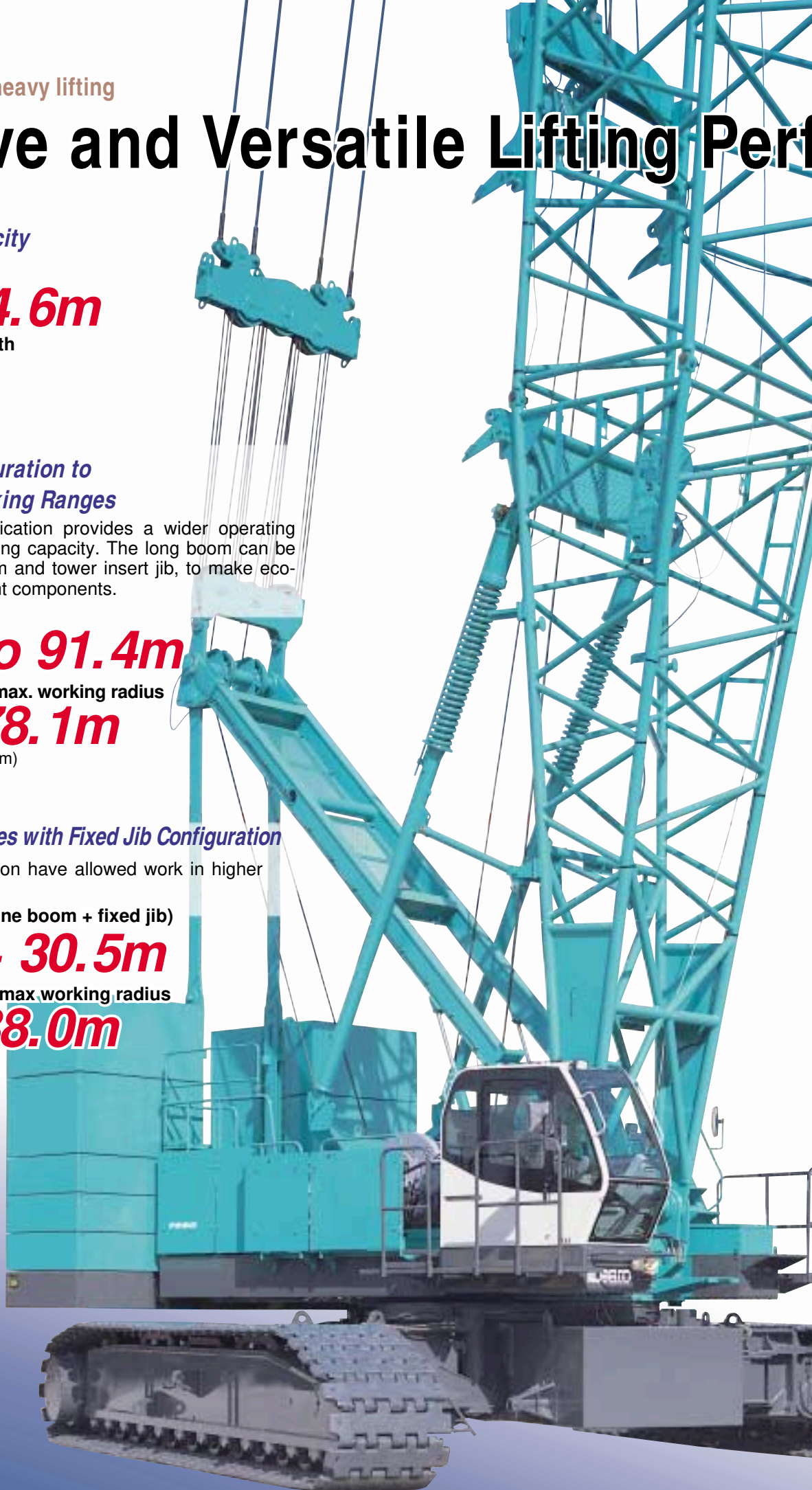

Performance

High-Output Engine

The engine has an impressive rated output of 247 kW and complies with NRMM (Europe) Stage IIIA and US EPA Tier III exhaust emissions regulations. All of this power works with KOBELCO's unique Engine Speed Sensing (ESS) control system and new hydraulic systems to ensure stable and smooth simultaneous operations.

Engine output **247 kW**
Meets NRMM (Europe) Stage IIIA



High-Speed Lifting Increases Work Efficiency

The main and auxiliary winches deliver a fast maximum hoisting and lowering speed of 110 m/min that improves operational efficiency on high-rise jobs.

Max. line speed
110m/min (First layer)

New Crawler Design Improves Performance

Large crawlers have been added to further improve stability, while keeping the tail swing radius to just 5,850 mm. The result is a machine with great lifting capacity that can operate in a minimum of onsite space.

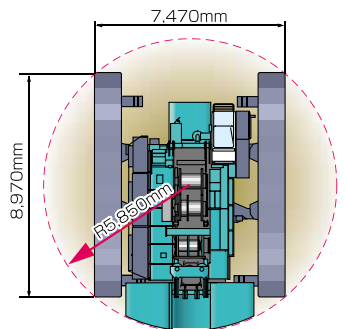

High-Performance Winches Accommodate a Wide Range of Jobs



The winch shown in this photo is for tower jib specification.

Choice of Two Types of Winch

The 7250 features non free-fall winches as standard that provides constant hydraulic power to the winches to prevent accidental free-fall through operator error. An optional free-fall winch (with wet-type disc brake) is also available, which delivers highly reliable performance for material handling and general foundation work.

Wide and Large Capacity Winches

The wide hoist winches provide an impressive spooling capacity of 53 m on the first layer with ϕ 28 mm hoist rope. Their large capacity and large diameter help to prevent uneven spooling and wear while ensuring smooth operation when using a long boom for high-rise work.

Spooling capacity (first layer) **53m**

Winches with a Powerful Line Pull Handle Hard Work with Ease

Through the efficient match-up of a high-output engine and high-performance hydraulic motors, the winches deliver plenty of line pull for single-line work. There's also ample capacity for heavy loads when they first clear the ground, and other tough jobs.

Rated line-pull (main/aux.)

Single line **132kN {13.5tf}**

Non Free-fall Winch (Standard)

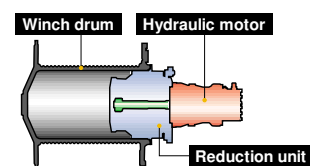

Wet-Type Disc Brake System (Optional)

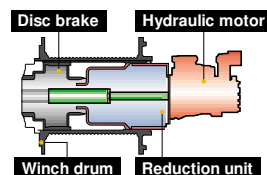

KOBELCO's new oil-cooled wet-type multi-disc brake system is first in its class and provides quiet, dependable braking power. The multiple discs are self-adjusting and self-equalizing. Forced-oil circulation keeps brake temperatures cooler during long, continuous operations and ensures smooth braking. The completely enclosed system eliminates the possibility of outside contamination, providing years of problem-free service life. In optional free-fall mode, the brake pedal is easily depressed to reduce operator fatigue.

For greater work efficiency

Smooth Operation and Control

New Hydraulic System Improves Simultaneous Operations

In case of luffing tower operation, the aux winch is used for jib hoisting. And the line speed reduction occurs by main hoist-lower and jib hoist-lower combined operation due to hydraulic pressure interference with conventional series hydraulic circuit (conflux hydraulic circuit).

The 7250 adopts one-pump to one-motor system (independent hydraulic circuit) for main, aux hoist and boom hoist. This is completely interference-free hydraulic circuit to perform smooth combined operation of main, aux, boom and jib hoist-lowering without any shocks and speed reduction in all ranges of winch speed and load condition.

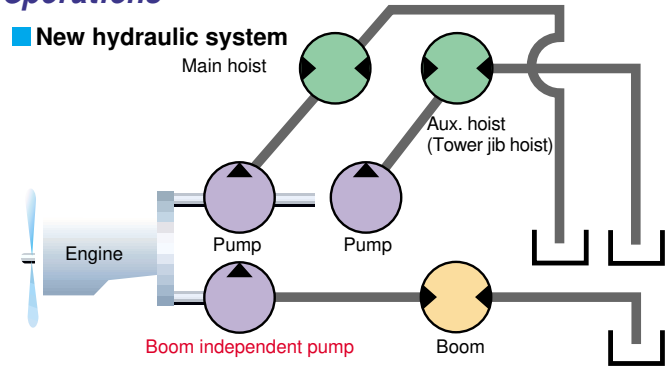

Selectable Swing Modes to Match the Job at Hand

Free Swing Mode (High/Low):

This mode is designed for material handling and other cycle-duty operations that require consecutive swing cycles. The swing is completely free and can be operated at High or Low speed to suit job requirements.

Neutral Brake Swing Mode:

When the crane is working on a slope in Free Swing Mode, it may swing in an unintended direction as soon as the swing parking brake is released. To prevent this, the Neutral Brake Swing Mode reduces operating speeds by lowering the flow of oil in the hydraulic circuit, thus making swing starts and stops easy to control when working on a slope or in windy conditions.

Swing speed is also reduced in this mode to prevent the load from moving sideways.



Control Levers Connected Directly to Pilot Valves for Smooth Operation

The control levers regulate the pilot valves directly to reduce the amount of play and ensure smooth, precise hoisting start-ups and inching. Control is light and sure, with almost no clatter even over long operating periods.

Winch Speed Controller

The speeds of the main winch, auxiliary winch and boom hoist can be set independently with trimmer controls.



■ Hydraulic pilot system detects swing reaction force.

■ Electric throttle with a twist grip ensures sensitive engine control.



■ Red switch on the boom lever grip allows easy inching control for hoist, boom hoist, and travel. The operator can activate it without taking his hands off the boom hoist lever.



■ The drum turning sensor enables sensing start of hoisting and lowering (main and aux winches only) by touching the top of the hoisting lever grip (optional).



For better man-machine communication

Excellent Cab with Enhanced Functions

Multi-Function LMI Display

The newly designed load moment indicator (LMI) system features a large, easy-to-read LCD display. The rated load, actual load, load ratio, and other information are displayed in large characters. Warnings and other items are displayed in color, and text messages and alarms alert the operator to prevent dangerous conditions from developing. Other information can also be displayed, including a rated load chart and rated load curve, in addition to a function that regulates the working range.



• Over-load alarm display

• Working area display



Multi-Display

The easy-to-read LCD multi display provides information on the current status of such functions as engine rpm, maintenance, and on-board trouble-shooting, so that the operator has an ongoing, real-time assessment of the machine's condition at a glance.



Normal Displays

- Engine speed (Lifting height*¹)
- Engine oil change interval
- Reeving number for main/aux winch wire rope
- Low-speed switch status
- Wind speed*²

*¹ With the optional lifting height gauge installed

*² With optional anemometer installed

Warning Displays

- Warning (malfunction, maintenance information, etc.)
- Self-diagnostic function (detects malfunctions in solenoid valves, sensors, etc.)

Comfortable 940mm-Wide Cab

- Air conditioner
- Fully adjustable, high backed seat with a headrest and armrests
- Intermittent wipers and window washers
- Sun visor
- Roof blind



Clear, Panoramic View

The 7250 has a new cabin design with sash-less front and top glass that provides a panoramic frontward and skylight view. The glass also has less curvature to minimize distortion. The front upper window has been broadened on both sides for a view that is 31% wider than a conventional cab, while the top-window view is widened toward the rear.



Visual comparison of new and conventional cabs

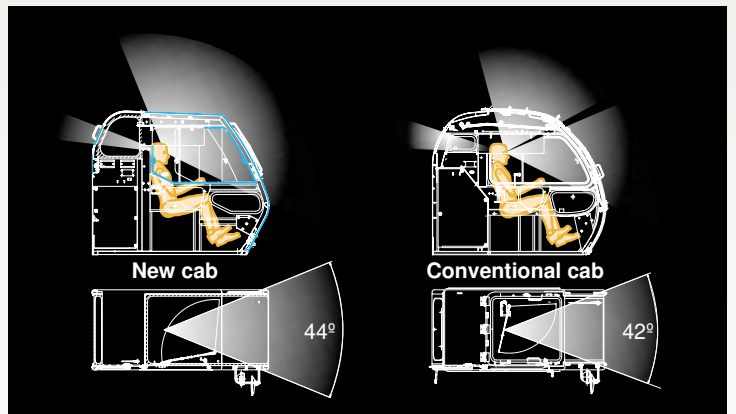

To ensure safe assembly and increase actual working hours

Excellent Transportability and Assembly

Base Machine Width of 3.2m (without Boom Base) and 3.4m (with Boom Base)

Swing Cab

The cab can be easily turned by hand toward the front of the machine during transportation so that the upper machinery fits within a width of 3.2m. This enables the machine with axles to be transported on a trailer.

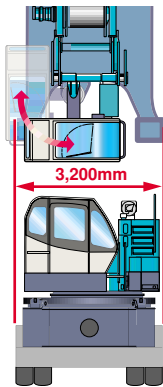

Transport with Boom Base

It is also possible to transport with boom base. The width and weight is within 3.4m and 44.5t. This eliminates installation of boom base and boom hoist rope in jobsite, swiftly ready for job.

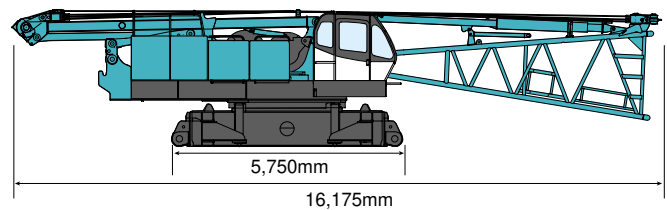
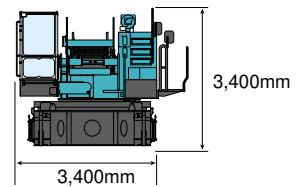

Light and Compact Super-Structures

The boom hoist winch is pin-connected to upper structure for easy assembly and disassembly for transportation. The new and unique upper structure design provides the benefit of light and compact base machine good for transportation.

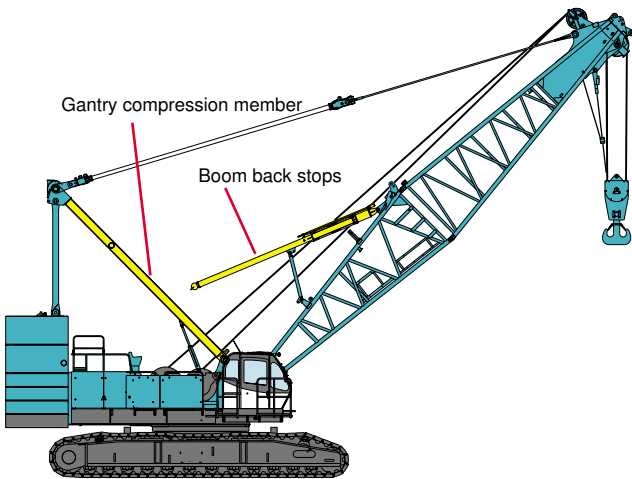

Unique upper structure design

- (1) Location of gantry compression-member foot.
- (2) Complete separation of boom back-stops from upper structure.

Boom Assembly/Disassembly Mode

The boom assembly/disassembly mode, which is used to release the over-hoist prevention function to facilitate boom assembly and disassembly, is activated with a switch located under the multi-function LCD display of the load moment indicator (LMI). (This switch is different from the switch that releases the auto-stop functions for over-load and hook over-hoist.) When the boom is lifted to a certain angle, it is automatically deactivated and the LMI function is automatically re-engaged to ensure that the boom assembly/disassembly function is used only when needed.



Nesting Boom Design

The tower insert jib can be easily nested in the insert boom by using the optional stowing guide rollers. This reduces the number of trailers needed for transport and helps to minimize required storage space.

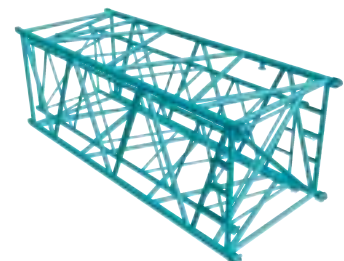

Faster Attachment Assembly and Disassembly

A variety of new mechanisms greatly reduce the time needed to assemble attachments. This results in lower labor and assist-crane costs, and greater productivity on the job.



■ The stowing bracket makes securely tighten the guy cables on to boom inserts for transportation. This also ensures that the guy cables are correctly installed during assembly (optional).

■ The boom connector pin holder prevents the loss of boom connector pins during assembly/disassembly and transportation.

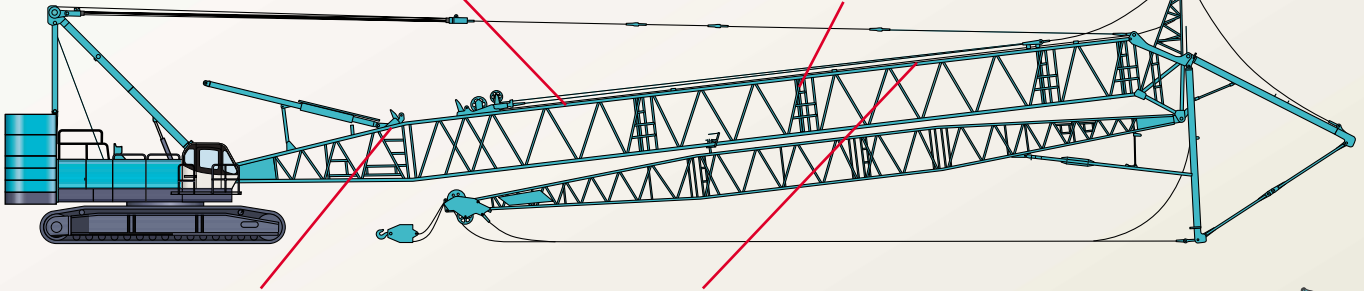

■ The upper spreader stowing guide makes it easy to connect guy cables.



■ The rail for the luffing tower jib upper spreader, installed at the back of the insert boom, enables the spreader to move without the assist crane when assembling.

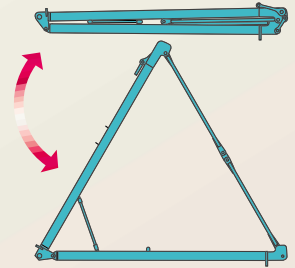

■ The foldable strut with a support makes easy assembly of strut on ground.

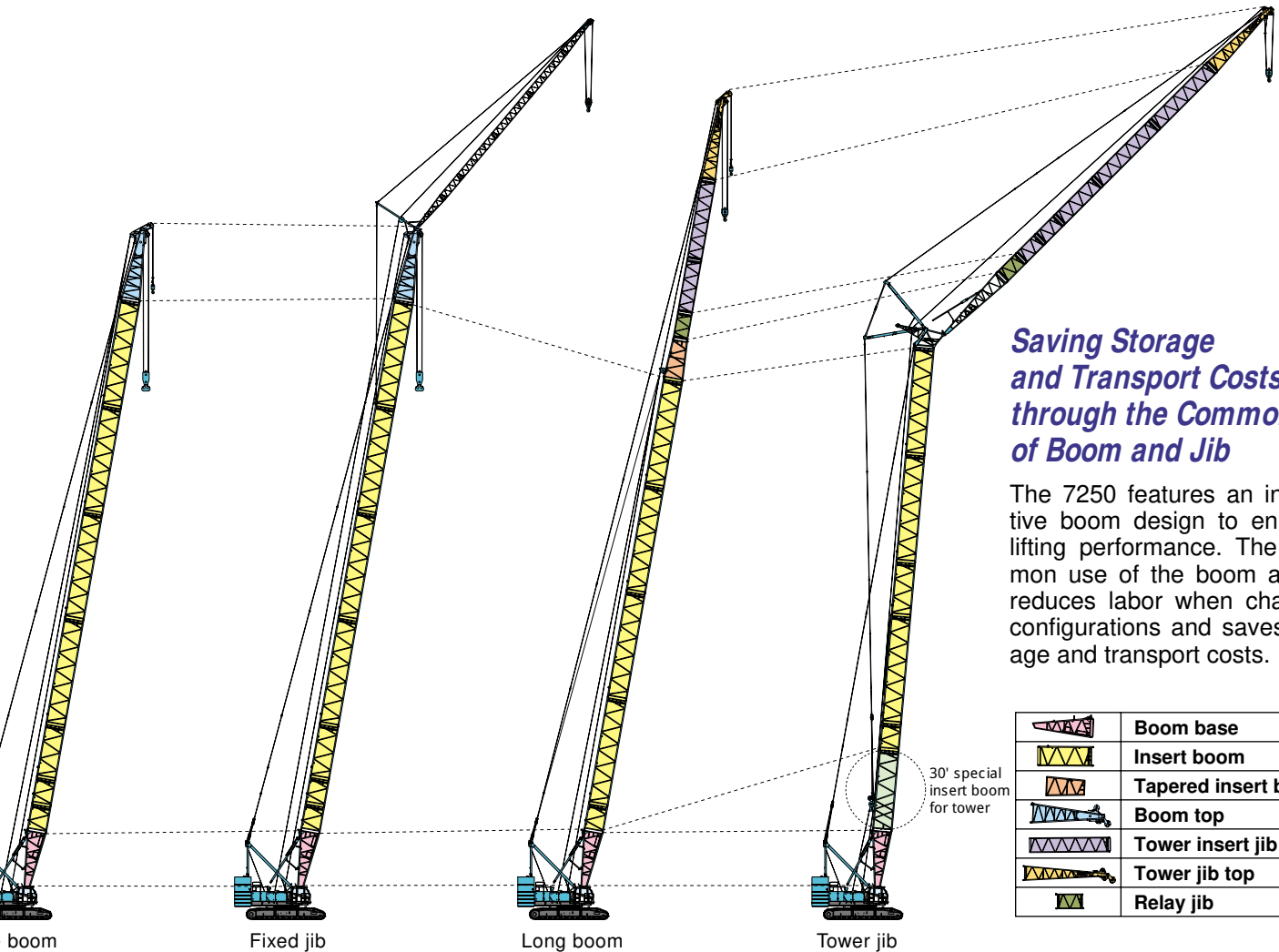

Saving Storage and Transport Costs through the Common Use of Boom and Jib

The 7250 features an innovative boom design to enhance lifting performance. The common use of the boom and jib reduces labor when changing configurations and saves storage and transport costs.

	Boom base
	Insert boom
	Tapered insert boom
	Boom top
	Tower insert jib
	Tower jib top
	Relay jib

30' special insert boom for tower

No compromise in KOBELCO's safety policy

Safe, Environmentally-Conscious

Two-Stage System to Prevent Boom and Jib Over-Hoists

With primary and secondary over-hoist prevention devices, this new safety system can prevent boom over-hoist at two stages. The primary stop function is activated when the boom or tower approaches the critical angle-to-ground during hoisting. This new system monitors the angle-to-ground of the boom, tower or tower jib with a sensor, and swiftly alerts the operator of danger. For the tower, the angle-to-machine is also monitored at this stage. The secondary stop function uses a device that monitors the angle-to-machine of the boom, tower, or tower jib through a limit switch fitted to the boom and jib back-stops. It stops the machine automatically to prevent it from working outside of the safety range, and once activated it cannot be cancelled.

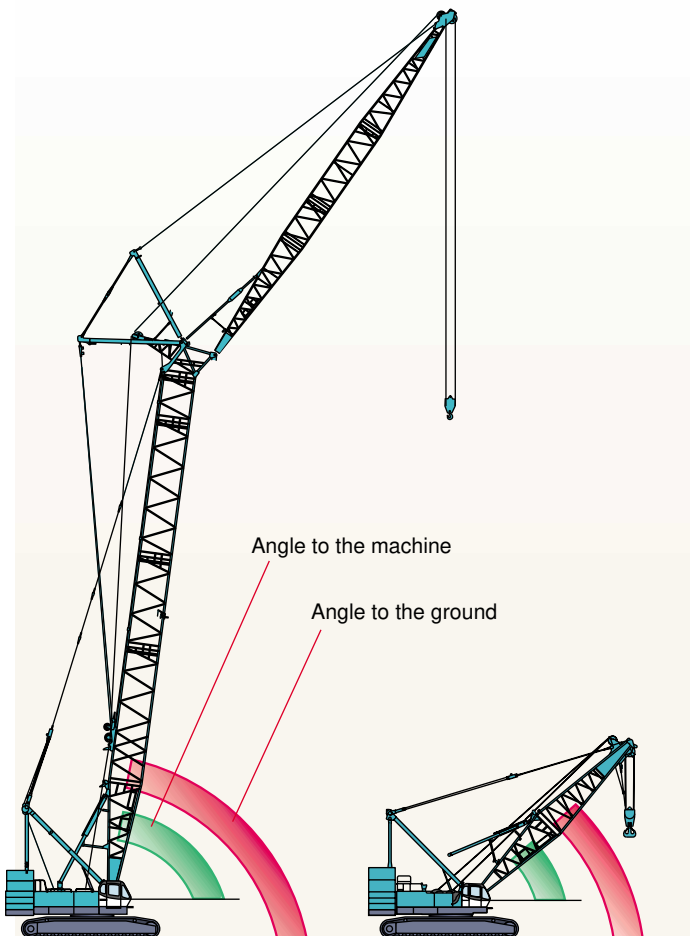

Automatic Soft-Stop Function Reduces Shocks

This function is activated automatically when boom or tower jib lowering, or boom hoisting is stopped by the over-load prevention system and over-hoist prevention system. It makes for a smooth stop and reduces dangerous swinging of the load.

Automatic Stop Release Switch with Safety Function

The automatic stop system prevents over-load, hook over-hoist and boom over-hoist. To deactivate the system, a two-stage release procedure is employed that uses a master key and separate switches. This makes it easy to supervise the use of the single key and prevent unauthorized release of the automatic stop system.



Other Safety Features

- Swing flashers and warning buzzer warn surrounding workers when the machine is swinging.
- Function lock lever helps prevent accidental operation when the operator enters or leaves the cab.
- Directional markings on the crawlers make it easy to see which direction the crawlers will move.
- One-way call supports the safety of onsite personnel (optional).
- External lamp for over-load alarm notifies surrounding workers of the load condition (optional).
- Cameras and color monitor provide views of the rear of the machine, the main and auxiliary winches, and the boom hoist winch (optional).

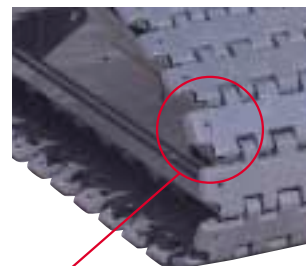

• Directional marking



• Function lock lever



• One-way call (optional)



Design

Side-Engine Layout for Easy Maintenance

A new engine layout on the side of the machine provides easy access for routine inspections and servicing. Maintenance crews can access the entire power plant just by opening the side door.

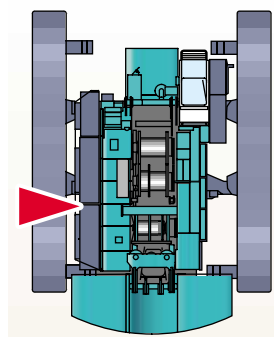

Super Fine Filter, a Long-Life Filter for Hydraulic Oil

The large-capacity, super-fine filter is made of a high-performance filter medium consisting of glass fiber reinforced with steel wires. The replacement cycle is extended to four times longer than that of conventional filters to reduce lifelong operating costs.



Photomicrograph (x250)

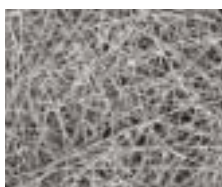

• Super fine filter (glass fiber)

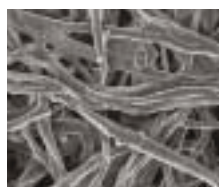

• Conventional filter (paper fiber)

Complying with Worldwide Exhaust Gas Regulations

Adopting the low pollution engine, the 7250 meets NRMM (Europe) Stage IIIA exhaust emissions regulations and U.S. EPA tier III.

Complying with Japanese Noise Regulations

The 7250 is designed with advanced Kobelco low noise construction technologies, as specified by the Japanese Ministry of Land, Infrastructure and Transport.

■ Main Specifications (Model: 7250-2F)

Crane Boom	
Max. Lifting Capacity	250 t/4.6 m
Max. Length	76.2 m
Long Boom	
Max. Lifting Capacity	37.5 t/14.4 m
Max. Length	91.4 m
Fixed Jib	
Max. Lifting Capacity	22.7 t/15.0 m
Max. Combination	76.2 m + 30.5 m
Tower Jib	
Max. Lifting Capacity	25 t/18.0 m
Max. Combination	64.1 m + 51.8 m
Tower Angle	60°~90°
Main & Aux. Winch	
Max. Line Speed	110 m/min (1st layer)
Rated Line Pull (Single Line)	132 kN {13.5 tf}
Wire Rope Diameter	28 mm
Wire Rope Length	390 m (Main) 220 m (Aux.)
Brake Type	Spring-set hydraulically released (Negative)
Free-Fall Brake Type	Wet-type multiple disc brake (Optional)

Working Speed	
Swing Speed	2.2 min ⁻¹ {rpm}
Travel Speed	1.1/0.7 km/h
Power Plant	
Model	Hino P11C-UN
Engine Output	247 kW/2,000 min ⁻¹ {rpm}
Fuel Tank Capacity	400 liters
Hydraulic System	
Main Pumps	4 variable displacement
Max. Pressure	31.9 MPa {325 kgf/cm ² }
Hydraulic Tank Capacity	600 liters
Weight	
Operating Weight*	Approx. 211 t
Ground Pressure*	122 kPa {1.25 kgf/cm ² }
Counterweight	97.1 t (Upper), 20.0 t (Lower)
Transport Weight**	44.5 t

* Including upper and lower machine, 97.1 ton counterweight and 20.0 ton carbody weight, basic boom, hook, and other accessories.

**Base machine with boom base, carbody, gantry, trans-lifter, lower spreader, upper spreader, main and aux. winches including wire rope, and boom hoist winch including wire rope. Units are SI units. { } indicates conventional units.

■ General Dimensions (Unit:mm)

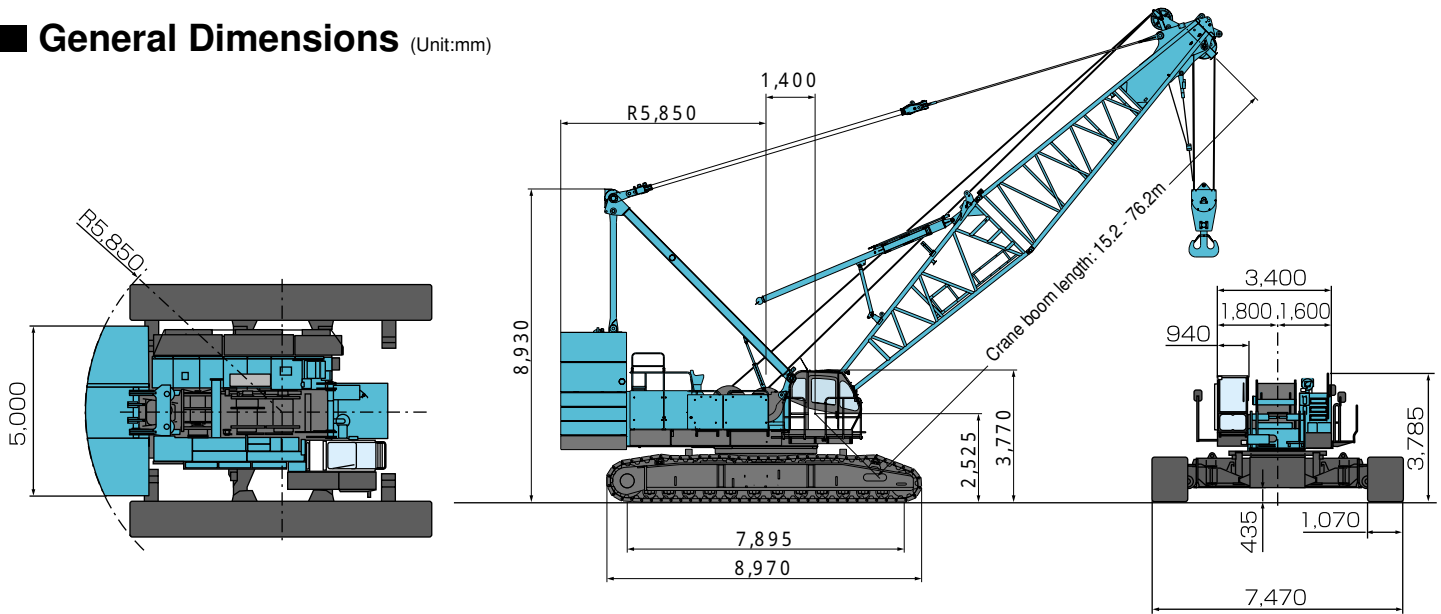

Note: This catalog may contain photographs of machines with specifications, attachments and optional equipment not certified for operation in your country. Please consult KOBELCO for those items you may require. Due to our policy of continual product improvements all designs and specifications are subject to change without advance notice.

Copyright by KOBELCO CRANES CO., LTD. No part of this catalog may be reproduced in any manner without notice.

KOBELCO CRANES CO., LTD.

17-1, Higashigotanda 2-chome, Shinagawa-ku, Tokyo, 141-8626 JAPAN
Tel: +81-3-5789-2130 Fax: +81-3-5789-3372

Inquiries To: