

**SHETHIA**

# GOTTWALD

Truck Mounted Crane  
with Lattice-Type Jib

- 113 m Hauptausleger
- 95 m Wipp-Spitzenausleger

**AK850/1100 t**

Lifting Capacity 850 / 1100 t



## Version AK850 / 1100t - 1

Crane as one unit.  
By crane operation no additional  
ballast is required on pedestal  
max travelling speed 62 km/h

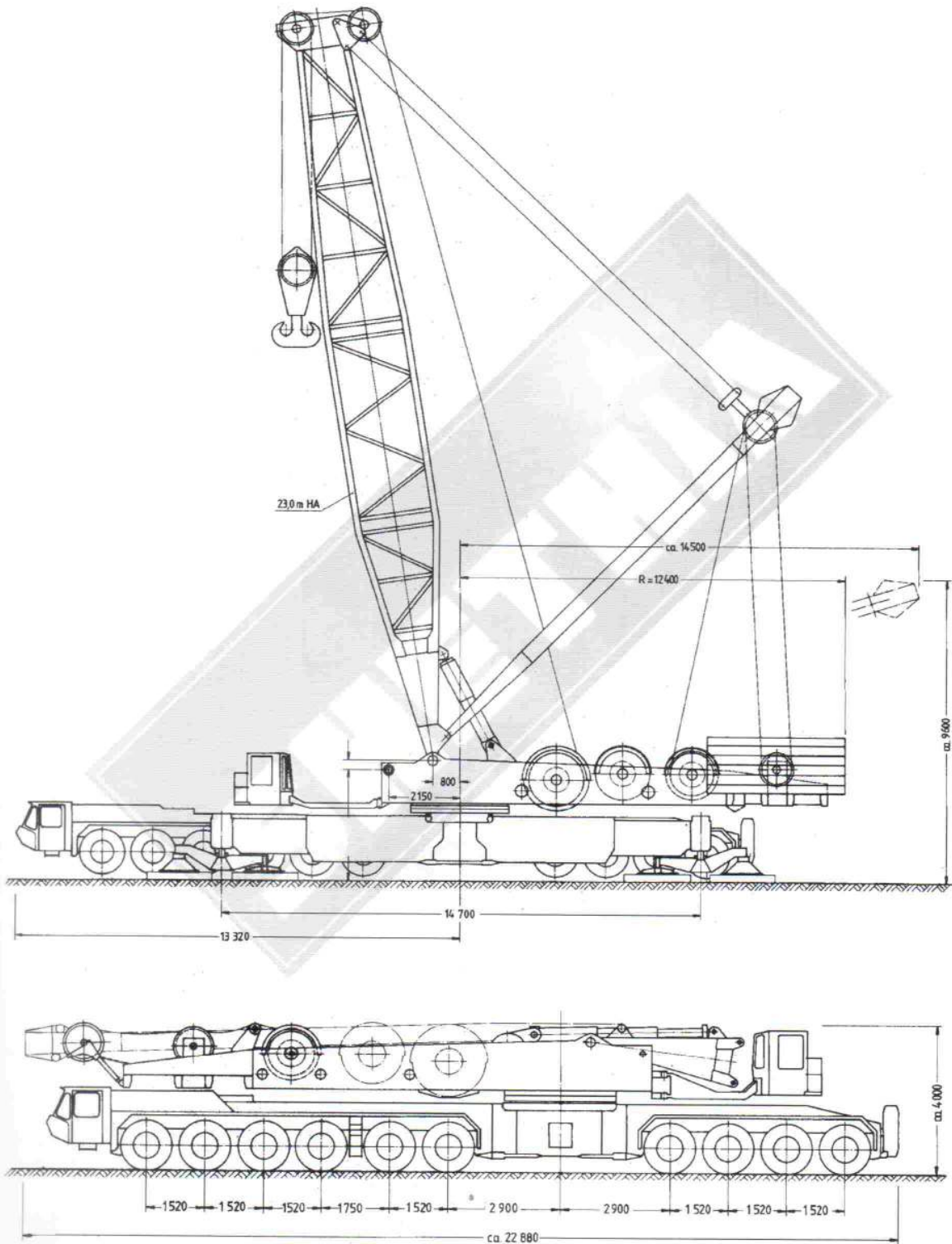

Transport Weight : approx 112 t  
Axle loads : approx 12 t

## Version AK850 / 1100t - 2

Crane as transport on an articulated chassis  
For crane operation the tractor will be removed.

The pedestal is to be loaded with 60 tons additional ballast.

Tractor and trailer may be used for other transportation.

The 4-axied trailer is equipped with 8 single axles (pendulum axes)

Max. travelling speed : 62 km/h

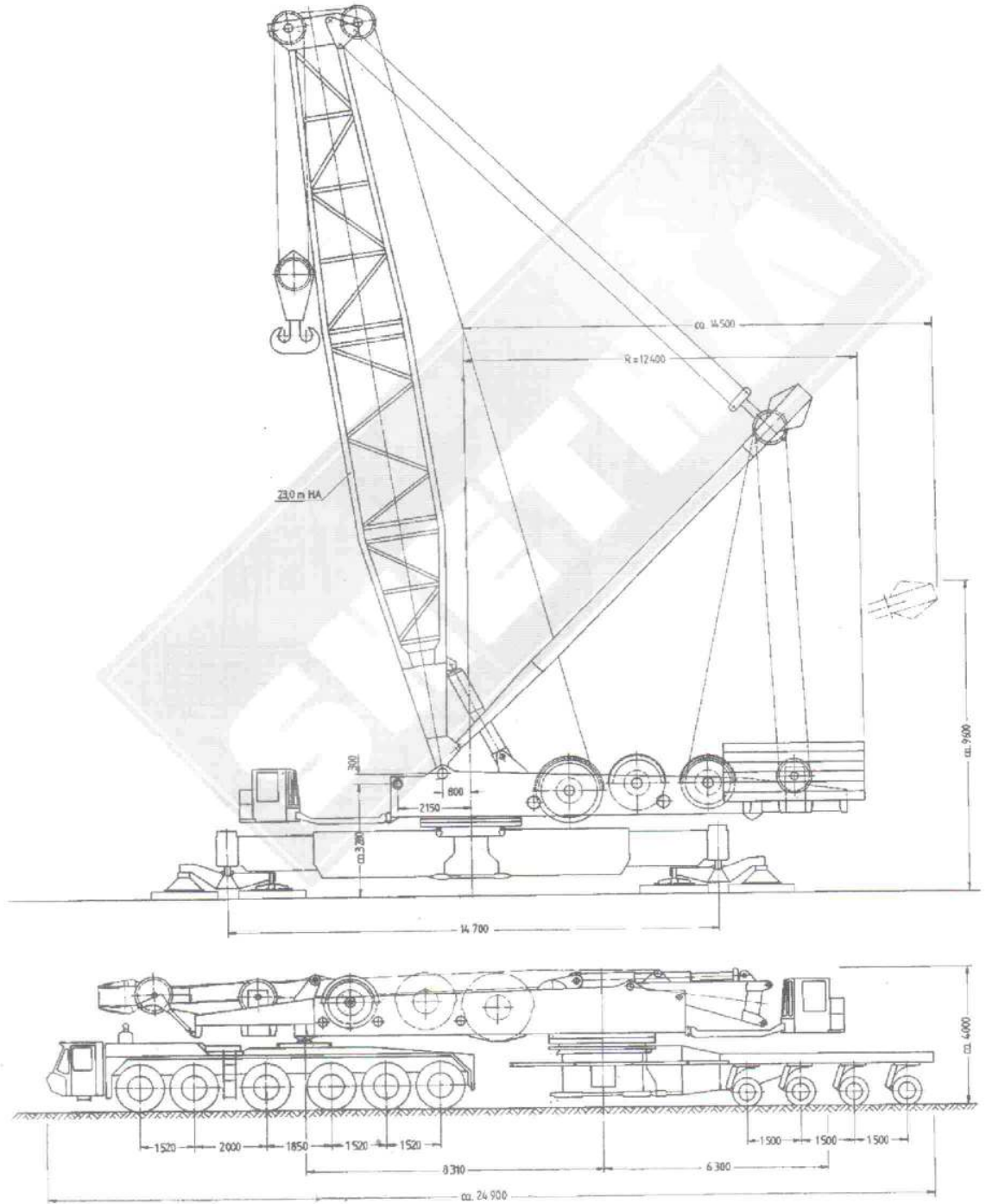

Transport Weight : approx 119 t  
Axles loads : approx 12 t

## Main Jib (Capacities in t) DIN-Ratings

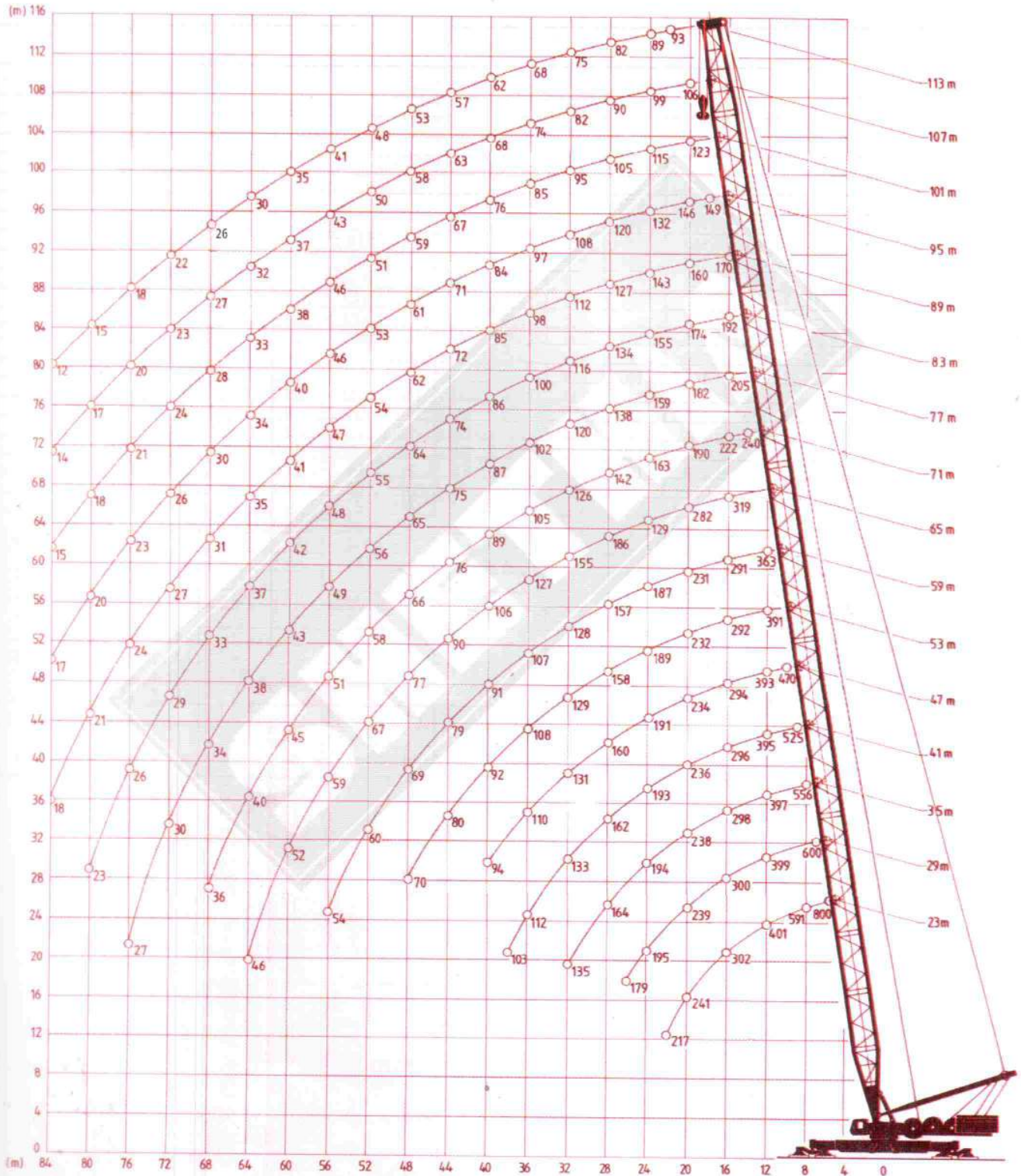

## Lifting Capacities (t) on Main Jib

360° slewable, outrigger base 14,7 x 14,7 m  
Counterweight : Superstructure 206 t  
Undercarriage 60t<sup>1</sup>

DIN-Ratings

Ausladung Radii Protee m	Main boom lengths															
	23 m	29 m	35 m	41 m	47 m	53 m	59 m	65 m	71 m	77 m	83 m	89 m	95 m	101 m	107 m	113 m
5	800 <sup>2)</sup> / 650															
6	746 <sup>2)</sup> / 650															
7	650	600														
8	591	589	556													
9	529	527	526	525												
10	478	476	475	473	470											
12	401	399	397	395	393	391	363	319 <sup>3)</sup>								
14	344	342	341	339	337	335	334	306	240	210 <sup>4)</sup>						
16	302	300	298	296	294	292	291	282	222	205	192	170 <sup>5)</sup>				
18	268	266	265	263	261	259	258	256	205	194	184	168	1496 <sup>6)</sup>			
20	241	239	238	236	234	232	231	229	190	182	174	160	146	123	106 <sup>7)</sup>	
22	217	215	214	212	210	208	207	206	176	170	165	152	139	121	103	93
24		195	194	193	191	189	187	186	163	159	155	143	132	115	99	89
26		179	178	176	174	172	171	169	152	148	144	135	126	110	94	85
28			164	162	160	158	157	155	142	138	134	127	120	105	90	82
30			148	146	145	143	142	141	134	129	125	119	114	100	86	78
32			135	133	131	129	128	127	126	120	116	112	108	95	82	75
34				121	120	118	117	116	115	111	107	105	103	90	78	71
36				112	110	108	107	106	105	102	100	98	97	85	74	68
38				103	102	100	99	98	96	94	93	92	91	81	71	65
40					94	92	91	90	89	87	86	85	84	76	68	62
44						80	79	77	76	75	74	72	71	67	63	57
48						70	69	67	66	65	64	62	61	59	58	53
52							60	59	58	56	55	54	53	51	50	48
56							54	52	51	49	48	47	46	44	43	41
60								46	45	43	42	41	40	38	37	35
64									40	38	37	35	34	33	32	30
68										34	33	31	30	28	27	26
72										30	29	27	26	24	23	22
76										27	26	24	23	21	20	18
80												21	20	18	17	15
84												18	17	15	14	12
88																
Zulässige Windstärke Permissible wind force Force de vent admissible (Beaufort)	8	7	7	7	6	6	6	5	5	5	4	4	4	4	4	4

### Remarks :

- 1) onle required for AK 850 / 1100t - 2
- 2) special boom head is required
- 3) at R = 13 m
- 4) at R = 15 m
- 5) at R = 17 m
- 6) at R = 19 m
- 7) at R = 21 m

### Remarks concerning the Lifting Capacities

Lifting Capacities = Actual Load + Snatch  
Block + Auxiliary Equipment.

The Lifting capacities are valid for even and  
stable ground.

DIN : The Lifting Capacities do not exceed  
75% of the tipping load. They correspond to  
DIN 1509.2 (Test load) = 1,25 x Hoist load  
+ 0.1 x Jib-own weight, reduce on the Jib  
Head )

We reserve the right to modify the  
construction, the technical data as well  
as the weights and dimensions.

## Crane with luffing fly jib

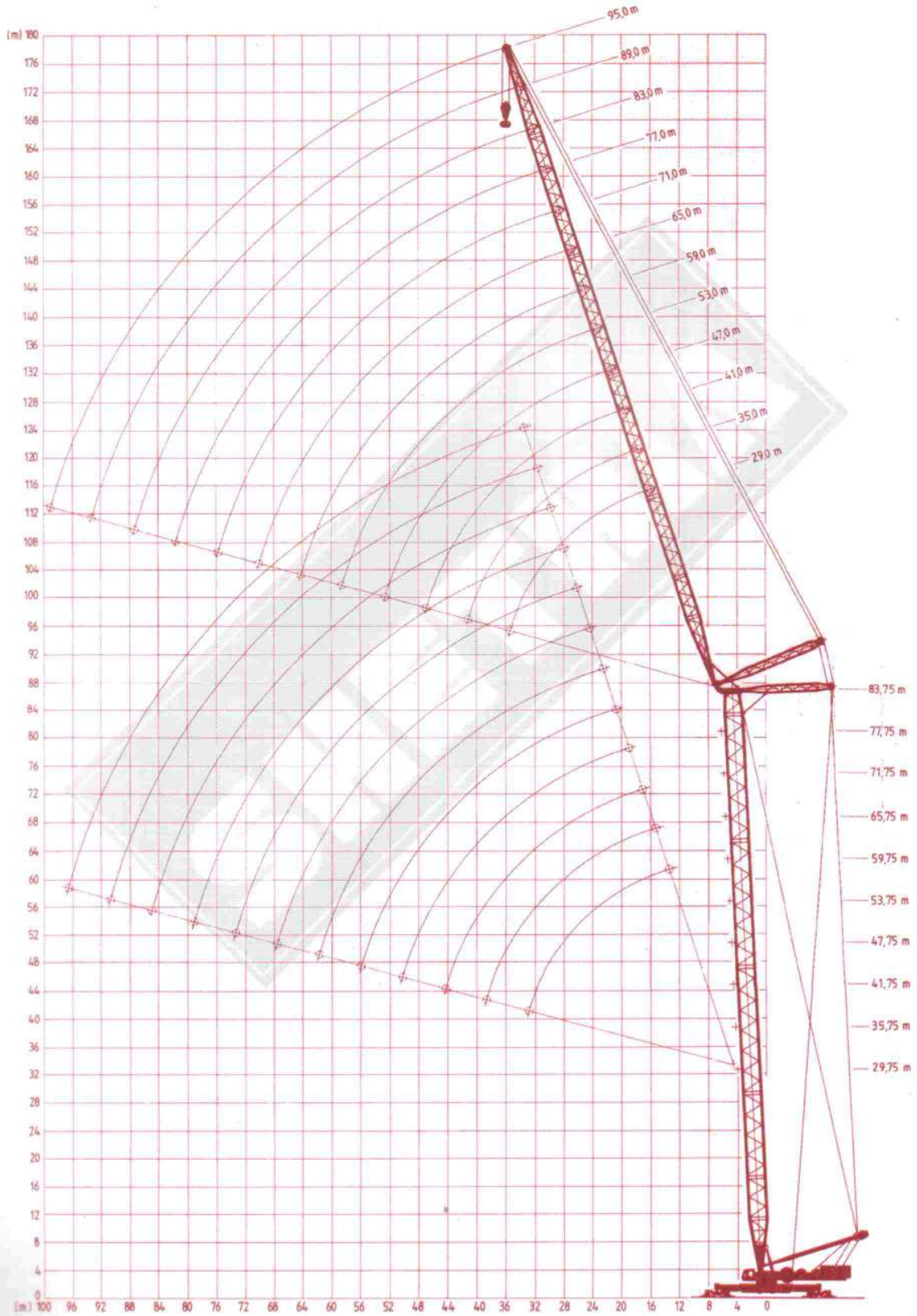

## Lifting Capacities (t) Luffing Fly Jib

On Outrigger Base 14,7 x 14,7 m  
Slewing Range 360°  
Counterweight : Superstructure Max 206 t  
Undercarriage Max 60t')  
DIN-Ratings

Turmlänge Tower Length Longueur tour m	Ausladung Radii Portee m	Luffing Fly Jib Lengths																		
		29 m	35 m	41 m	53 m	53 m	59 m	65 m	71 m	77 m	83 m	89 m	95 m							
23,75	16	236																		
	18	236	215																	
	20	236	200	182																
	22	221	196	172	148	125														
	24	201	182	163	144	124	110													
	26	185	170	155	140	124	108	92												
	28	171	159	147	136	121	106	91	76											
	30	158	149	140	132	117	102	88	75	65										
	32	143	137	132	127	113	99	86	74	64	55									
	34		126	124	122	109	96	84	73	63	54	45								37
	36		121	119	117	105	94	82	72	62	53	45	37							36
	38			114	112	101	90	79	71	61	52	44	36							35
	40			109	107	97	87	77	70	60	51	43	35							34
	44				93	86	79	73	66	58	50	42	34							33
	48				84	79	74	69	64	56	49	41	33							32
	52					69	67	65	62	55	48	40	32							31
	56						63	61	59	53	47	39	31							31
	60							58	58	52	46	38	31							30
	64							54	54	49	45	37	30							30
	68								51	46	42	36	30							28
72								48	44	41	34	28							28	
76									42	40	34	28							27	
80										37	32	27							26	
84											31	26							25	
88											30	25								
Zulässige Windstärke Permissible wind force Force de vent admissible (Beaufort)		6	5	5	5	4	4	4	4	4	3	3	3							

Turmlänge Tower Length Longueur tour m	Ausladung Radii Portee m	Luffing Fly Jib Lengths																		
		29 m	35 m	41 m	47 m	53 m	59 m	65 m	71 m	77 m	83 m	89 m	95 m							
29,75	16	236																		
	18	236	215																	
	20	236	200	182																
	22	221	196	172	148															
	24	201	182	163	144	125														
	26	185	170	155	140	124	108	92												
	28	171	159	147	136	121	106	91	76											
	30	158	149	140	132	117	102	88	75	65										
	32	143	137	132	127	113	99	86	74	64	55									
	34		126	124	122	109	96	84	73	63	53	45								37
	36		121	119	117	105	93	82	72	62	53	45	37							36
	38			114	112	101	90	79	71	61	52	44	36							35
	40			109	107	97	87	77	70	60	51	43	35							34
	44				93	86	79	73	66	58	50	42	34							33
	48				84	79	74	69	64	56	49	41	33							32
	52					69	67	65	62	55	48	40	32							31
	56						63	61	59	53	47	39	31							31
	60							58	58	52	46	38	31							30
	64							54	54	49	45	37	30							30
	68								51	46	42	36	30							28
72								48	44	40	34	28							28	
76									42	38	33	28							27	
80										35	31	27							26	
84											30	26							25	
88											29	25								
Zulässige Windstärke Permissible wind force Force de vent admissible (Beaufort)		6	5	5	5	4	4	4	4	4	3	3	3							

1) Only required for AK850 / 1100t-2  
Remarks concerning the lifting capacities :  
See page 5

## Lifting Capacities (t) Luffing Fly Jib

On Outrigger Base 14,7 x 14,7 m  
Slewing Range 360°  
Counterweight : Superstructure Max 206 t  
Undercarriage Max 60t<sup>1)</sup>  
DIN-Ratings

Turmlänge Tower Length Longueur tour m	Ausladung Radii Portee m	Luffing Fly Jib Lengths											
		29 m	35 m	41 m	47 m	53 m	59 m	65 m	71 m	77 m	83 m	89 m	95 m
35,75	16	236											
	18	236	214										
	20	233	200	175									
	22	214	192	170	148								
	24	196	178	161	144	124							
	26	180	166	153	140	123	106						
	28	166	156	146	136	120	104	88					
	30	154	146	138	131	116	101	86	72	62			
	32	142	136	131	126	112	96	84	71	62	53		
	34		125	123	121	108	95	83	70	61	53	45	
	36		121	119	117	105	93	81	69	61	53	45	37
	38		116	114	112	101	90	79	68	60	52	44	36
	40			109	107	97	87	77	67	59	51	43	35
	44			95	83	86	79	73	64	57	50	42	34
	48				82	77	72	68	63	56	49	41	33
	52					67	65	63	61	54	48	39	31
	56					63	61	59	58	52	47	39	31
	60						59	57	57	51	46	38	31
	64							56	54	49	45	37	30
	68								51	46	42	36	30
72								48	43	39	33	28	
76										36	32	28	
80											33	30	27
84												30	26
88												28	25
92													23
Zulässige Windstärke Permissible wind force Force de vent admissible (Beaufort)		6	5	5	5	4	4	4	4	4	3	3	3

Turmlänge Tower Length Longueur tour m	Ausladung Radii Portee m	Luffing Fly Jib Lengths											
		29 m	35 m	41 m	47 m	53 m	59 m	65 m	71 m	77 m	83 m	89 m	95 m
41,75	16												
	18	236	214										
	20	231	198	175									
	22	208	188	168	148								
	24	191	175	159	144	123							
	26	176	164	152	140	122	104						
	28	162	153	144	136	119	102	86					
	30	151	144	137	131	115	99	84	70				
	32	141	135	130	125	111	97	83	69	61			
	34		125	123	121	108	95	82	68	60	53	44	
	36		121	119	117	104	92	80	67	60	53	44	
	38		116	114	112	101	90	79	66	59	52	44	36
	40			109	107	97	87	77	65	58	51	43	35
	44			95	93	86	79	73	63	56	50	42	34
	48				80	75	71	67	62	55	49	41	33
	52					66	64	62	60	54	48	39	31
	56					62	60	58	58	52	47	39	31
	60						59	57	57	51	46	38	31
	64							54	54	49	45	37	30
	68							51	51	46	42	36	30
72								48	43	38	33	28	
76									39	35	31	28	
80										32	29	27	
84											31	28	26
88												27	25
92													23
Zulässige Windstärke Permissible wind force Force de vent admissible (Beaufort)		6	5	5	5	4	4	4	4	4	3	3	3

1) Only required for Ak850 / 1100 t-2  
Remarks concerning the lifting capacities :  
See page 5

## Lifting Capacities (t) Luffing Fly Jib

On Outrigger Base 14,7 x 14,7 m  
Slewing Range 360°  
Counterweight : Superstructure Max 206 t  
Undercarriage Max 60t<sup>1)</sup>  
DIN-Ratings

Turmlänge Tower Length Longueur tour m	Ausladung Radii Portee m	Luffing Fly Jib Lengths													
		29 m	35 m	41 m	47 m	53 m	59 m	65 m	71 m	77 m	83 m	89 m	95 m		
47,75	16														
	18														
	20	223	195	170											
	22	202	185	163	143										
	24	185	169	154	139	120									
	26	169	158	147	136	118	100								
	28	158	149	141	133	116	99	82							
	30	149	142	135	129	113	97	81	67						
	32	141	135	129	124	109	94	80	67	59					
	34		125	123	121	107	93	79	66	58	51				
	36			121	119	117	103	90	77	66	58	51	42		
	38			116	114	112	100	88	77	65	57	50	42	34	
	40				109	107	96	85	75	64	56	49	41	33	
	44				94	92	85	78	71	62	55	48	40	33	
	48					78	73	69	65	61	54	47	39	32	
	52						65	63	61	59	52	46	38	30	
	56						61	59	57	57	51	45	37	30	
	60							58	56	56	50	44	36	29	
	64								55	54	48	43	36	29	
	68									54	51	45	40	33	27
72										48	42	37	32	27	
76											38	34	30	26	
80												31	28	26	
84													30	28	26
88														27	25
92															23
Zulässige Windstärke Permissible wind force Force de vent admissible (Beaufort)		6	5	5	5	4	4	4	3	3	3	3	3	3	3

Turmlänge Tower Length Longueur tour m	Ausladung Radii Portee m	Luffing Fly Jib Lengths													
		29 m	35 m	41 m	47 m	53 m	59 m	65 m	71 m	77 m	83 m	89 m	95 m		
53,75	16														
	18														
	20	207	189												
	22	197	176	156											
	24	180	165	150	135										
	26	163	153	143	133	116									
	28	155	147	139	131	114	97	80							
	30	148	141	134	128	111	94	78	66						
	32	141	135	129	124	108	92	77	66	58					
	34	132	128	124	121	106	91	77	65	57	50				
	36		121	119	117	103	89	75	65	57	50	41			
	38			116	114	112	99	87	75	64	56	49	41	33	
	40				109	107	95	84	73	64	56	48	40	32	
	44				94	92	84	77	70	62	54	47	39	32	
	48					77	72	68	64	60	52	45	38	31	
	52						64	62	60	58	51	44	37	30	
	56						61	59	57	56	49	43	36	30	
	60							58	56	55	48	42	35	29	
	64								55	54	47	41	34	28	
	68									54	51	45	39	33	28
72										46	41	37	32	27	
76											38	34	30	26	
80												35	31	28	26
84													29	27	26
88														26	25
92															23
Zulässige Windstärke Permissible wind force Force de vent admissible (Beaufort)		5	5	5	4	4	4	3	3	3	3	3	3	3	3

1) Only required for AK850 / 1100t-2  
Remarks concerning the lifting capacities :  
See page 5

## Lifting Capacities (t) Luffing Fly Jib

On Outrigger Base 14,7 x 14,7 m  
Slewing Range 360°  
Counterweight : Superstructure Max 206 t  
Undercarriage Max 60t')  
DIN-Ratings

Turmlänge Tower Length Longueur tour m	Ausladung Radii Portee m	Luffing Fly Jib Lengths											
		29 m	35 m	41 m	47 m	53 m	59 m	65 m	71 m	77 m	83 m	89 m	95 m
59,75	16												
	18												
	20		178										
	22	192	171	151									
	24	175	160	145	130								
	26	157	147	138	129	112							
	28	151	143	135	128	111	93						
	30	146	139	132	126	109	92	75					
	32	140	134	128	123	106	90	74	64	56			
	34	131	127	124	121	105	89	74	64	56	49		
	36		121	119	117	102	87	73	64	56	48	39	
	38		116	114	112	99	86	73	63	55	47	39	32
	40			109	107	95	83	71	63	55	47	39	31
	44			94	92	84	76	68	61	53	45	38	31
	48				76	71	67	63	60	51	43	37	31
	52					63	61	59	57	49	42	36	30
	56					61	59	57	55	48	41	35	30
	60						58	56	54	47	40	34	28
	64							55	53	46	39	33	27
	68							54	51	44	38	32	27
72								44	40	36	31	27	
76									37	33	29	26	
80									35	31	28	26	
84										28	27	26	
88											26	25	
92												23	
Zulässige Windstärke Permissible wind force Force de vent admissible (Beaufort)		5	5	5	4	4	4	3	3	3	3	3	3

Turmlänge Tower Length Longueur tour m	Ausladung Radii Portee m	Luffing Fly Jib Lengths											
		29 m	35 m	41 m	47 m	53 m	59 m	65 m	71 m	77 m	83 m	89 m	95 m
65,75	16												
	18												
	20		164										
	22	178	163	146									
	24	170	155	140	126								
	26	151	142	134	126	110							
	28	148	140	133	126	108	90						
	30	145	138	131	125	107	89	72					
	32	140	134	128	123	106	89	72	63				
	34	131	127	124	121	104	88	72	63	55			
	36		121	119	117	101	86	71	63	55	47	38	
	38		116	114	112	98	84	71	62	54	46	38	31
	40			109	107	94	82	70	62	54	46	38	30
	44			94	92	83	75	67	61	52	44	37	30
	48				75	70	66	62	59	50	42	36	30
	52					62	60	58	56	48	41	35	29
	56					61	59	57	55	47	40	34	29
	60						58	56	54	46	39	33	28
	64							55	52	45	38	32	27
	68							54	50	43	37	32	27
72								43	39	36	31	27	
76									37	33	29	26	
80									35	31	28	26	
84										28	27	26	
Zulässige Windstärke Permissible wind force Force de vent admissible (Beaufort)		5	4	4	4	4	4	3	3	3	3	3	3

1) Only required for AK850 / 1100t-2  
Remarks concerning the lifting capacities :  
See page 5

## Lifting Capacities (t) Luffing Fly Jib

On Outrigger Base 14,7 x 14,7 m  
Slewing Range 360°  
Counterweight : Superstructure Max 206 t  
Undercarriage Max 60t<sup>1)</sup>

DIN-Ratings

Turmlänge Tower Length Longueur tour m	Ausladung Radii Portee m	Luffing Fly Jib Lengths											
		29 m	35 m	41 m	47 m	53 m	59 m	65 m	71 m	77 m	83 m	89 m	95 m
71,75	16												
	18												
	20												
	22		148	138									
	24	167	148	132	115								
	26	155	141	128	115	102							
	28	148	137	126	115	101	85						
	30	141	132	123	115	100	85	70					
	32	139	130	122	114	99	84	70	60				
	34	138	129	121	113	98	83	69	60	53			
	36		115	113	110	96	82	69	59	52	46	37	
	38			110	107	94	81	69	58	51	45	37	30
	40			105	102	90	79	68	57	50	44	36	29
	44				92	82	73	64	56	49	42	35	29
	48				78	72	66	61	54	47	41	35	29
	52						60	58	53	46	40	34	28
	56						59	57	52	46	40	34	28
	60							56	51	45	39	33	27
	64								50	44	39	32	26
	68									48	43	38	32
72									44	41	38	32	26
76											37	31	25
80											36	30	24
84												28	23
Zulässige Windstärke Permissible wind force Force de vent admissible (Beaufort)		4	4	4	4	4	4	3	3	3	3	3	3

Turmlänge Tower Length Longueur tour m	Ausladung Radii Portee m	Luffing Fly Jib Lengths											
		29 m	35 m	41 m	47 m	53 m	59 m	65 m	71 m	77 m	83 m	89 m	95 m
77,75	16												
	18												
	20												
	22		145	128									
	24	148	144	127	110								
	26	148	138	124	110	96							
	28	145	133	121	110	96							
	30	139	129	119	109	95	81	68					
	32	136	126	117	108	94	81	68	58				
	34	133	124	115	107	93	80	67	58	52			
	36		122	113	105	92	79	67	58	51	44		
	38			110	103	91	79	67	57	50	43	35	
	40			105	98	87	76	66	56	49	43	35	28
	44			90	88	79	71	63	55	48	41	34	28
	48				77	71	66	61	53	47	41	34	27
	52				70	66	62	58	52	46	40	33	27
	56					61	59	57	51	45	39	33	27
	60						58	56	50	44	38	32	26
	64						57	55	48	43	38	32	26
	68							53	47	42	37	31	25
72								44	40	37	31	25	
76									40	36	30	25	
80									39	34	23	23	
84										29	25	22	
Zulässige Windstärke Permissible wind force Force de vent admissible (Beaufort)		4	4	4	4	4	4	3	3	3	3	3	3

1) Only required for AK850 / 1100t-2  
Remarks concerning the lifting capacities :  
See page 5

## Lifting Capacities (t) Luffing Fly Jib

On Outrigger Base 14,7 x 14,7 m  
Slewing Range 360°  
Counterweight : Superstructure Max 206 t  
Undercarriage Max 60t')  
DIN-Ratings

Turmlänge Tower Length Longueur tour m	Ausladung Radii Portee m	Luffing Fly Jib Lengths											
		29 m	35 m	41 m	47 m	53 m	59 m	65 m	71 m	77 m	83 m	89 m	95 m
83.75	16												
	18												
	20												
	22		140	119									
	24	148	138	119	106								
	26	148	134	119	105	93							
	28	143	130	117	105	92	79						
	30	137	126	115	104	91	79	67					
	32	133	123	113	103	90	78	66	57				
	34	129	120	111	102	90	78	66	57	49			
	36		100	100	100	88	77	66	57	49	42		
	38		99	99	99	88	77	66	56	49	42	34	
	40		94	94	94	84	74	65	56	49	42	34	27
	44			86	84	77	70	63	55	48	41	34	27
	48				76	71	66	61	53	47	41	33	26
	52				70	66	62	58	52	46	40	33	26
	56					64	60	57	50	44	39	32	26
	60						59	56	49	43	38	32	26
	64						58	55	47	42	37	31	26
	68							53	46	41	36	30	25
72								44	40	36	30	25	
76									37	35	30	25	
80									34	32	27	23	
84										28	25	22	
88											22	21	
92												20	
Zulässige Windstärke Permissible wind force Force de vent admissible (Beaufort)		4	4	3	3	3	2	2	2	2	2	2	2

Turmlänge Tower Length Longueur tour m	Ausladung Radii Portee m	Luffing Fly Jib Lengths					
		29 m	35 m	41 m	47 m	53 m	59 m
89.75	22		119	119			
	24	148	119	118	102		
	26	146	119	116	101	90	
	28	141	119	113	100	88	77
	30	136	119	111	99	88	77
	32	131	119	109	98	87	76
	34	125	115	106	97	86	75
	36		96	96	96	85	75
	38		95	95	95	85	75
	40		90	90	90	84	72
	44			83	81	75	69
	48				75	70	65
	52				70	66	62
	56					64	60
	60						58
	64						57
Zulässige Windstärke Permissible wind force Force de vent admissible (Beaufort)		4	4	3	3	3	2

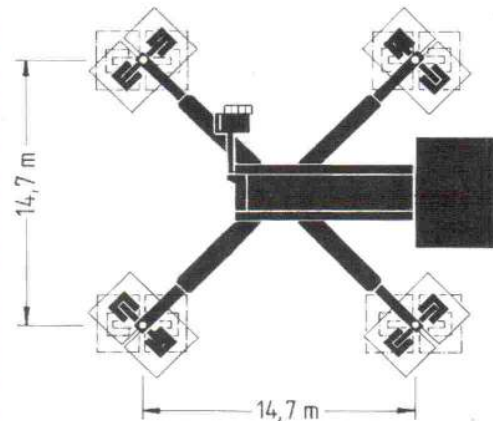





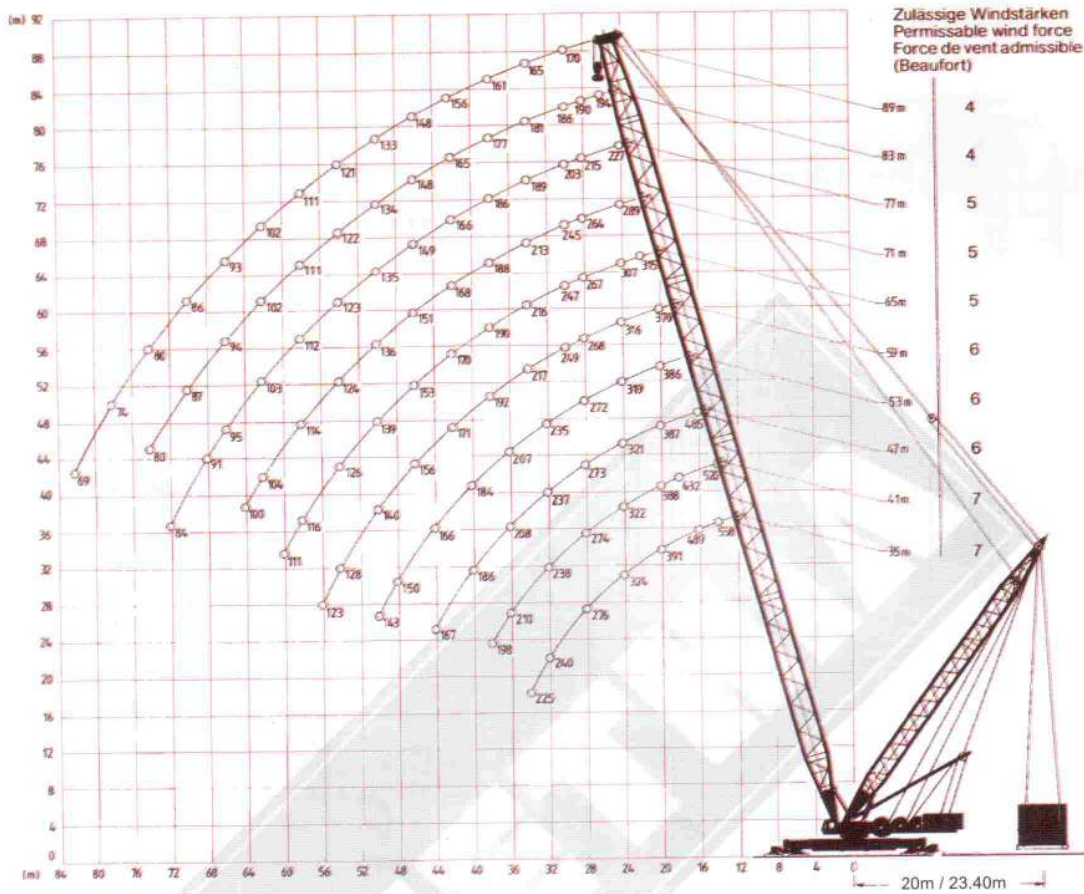

1) Only required for AK850 / 1100t-2  
Remarks concerning the lifting capacities :  
See page 5

## Crane with Maxi-lift-Equipment





### Lifting Capacities (t) Maxi-Lift-Equipment

with 43 m Maxi Lift Mast  
Outrigger Base 14,7 x 14,7 m (360°)  
DIN-Ratings

35m 43m 0-500 t 14,7 x 14,7m 206t 360° 75%

Hauptausleger Main Boom Fleche principale m		Maxi-Lift Counterweight					
		0T	100T	200T	300T	400T	
35	10	520	650	700			10
	11						11
	12	422	560	670			12
	14	380	500	590	700		14
	16	325	430	540	660	700	16
	18	285	380	480	580	680	18
	20	255	340	432	524	584	20
	22	230	310	391	480	565	22
	24	205	280	357	430	510	24
	26	185	260	328	400	470	26
	28	170	245	306	365		28
	30	155	225	280	345		30
	32	140	206	265	310		32
	34	130	199	246			34
36						36	
38						38	

1) Only required for AK850 / 1100t-2  
Remarks concerning the lifting capacities :  
See page 5

## Lifting Capacities (t) on Maxi-Lift-Equipment

with 43 m Maxi-Lift Mast  
Outrigger base 14,7 x 14,7 m (360°)  
DIN-Ratings

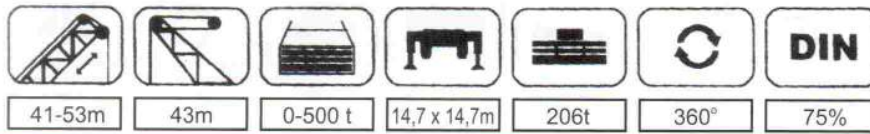

Hauptausleger Main Boom Flèche principale m		Maxi-Lift Conterweight						
		0T	100T	200T	300T	400T		500T
41	10							10
	11	420	570	700				11
	12	400	535	665				12
	14	360	490	580	700			14
	16	310	430	535	640			16
	18	272	379	478	570	642		18
	20	240	337	430	523	578		20
	22	225	307	387	480	563		22
	24	200	278	352	430	506	585	24
	26	183	253	324	395	467	538	26
	28	167	240	302	362	428	500	28
	30	152	220	287	342	395		30
	32	138	203	262	310			32
	34	128	196	244	300			34
	36	115	184	234	284			36
	38	110	174	225	274			38
47	12	390	515	655				12
	14	350	480	570				14
	16	295	430	528	630			16
	18	260	377	476	565	636		18
	20	230	334	428	524	575		20
	22	218	304	384	478	561	630	22
	24	195	276	348	430	503	582	24
	26	180	246	320	392	464	536	26
	28	164	232	298	359	424	500	28
	30	148	216	283	338	393	470	30
	32	136	200	260	310	374	420	32
	34	126	194	242	298	355		34
	36	114	182	232	281	336		36
	38	108	171	221	270			38
	40	99	163	208	254			40
	44	84	144	192	228			44
48							48	
50							50	
53	12							12
	14	330	475	560	660			14
	16	281	430	525	610			16
	18	250	375	475	560	630		18
	20	220	330	425	520	570		20
	22	212	300	380	475	560	638	22
	24	190	275	344	430	500	580	24
	26	176	240	316	390	460	530	26
	28	160	226	295	356	424	485	28
	30	145	212	280	335	390	450	30
	32	134	198	256	310	370	430	32
	34	124	191	240	295	350	400	34
	36	112	179	230	278	331	372	36
	38	105	168	218	266	316	348	38
	40	96	159	205	250	298	332	40
	44	81	140	188	224	265		44
48	73	122	168	203	236		48	
50	68	118	156	188			50	

## Lifting Capacities (t) on Maxi-Lift-Equipment

with 43 m Maxi-Lift Mast  
Outrigger base 14,7 x 14,7 m (360°)  
DIN-Ratings

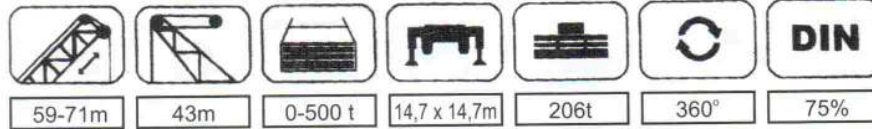

Hauptausleger Main Boom Fleche principale m		Maxi-Lift Counterweight						
		0T	100T	200T	300T	400T		500T
59	14	312	445					14
	16	278	415	520	590			16
	18	245	368	466	552	560		18
	20	219	322	420	510	556		20
	22	211	294	374	468	555		22
	24	190	272	338	424	493	577	24
	26	173	239	309	385	452	525	26
	28	158	225	290	354	417	480	28
	30	144	210	274	332	385	443	30
	34	122	188	238	288	343	389	34
	38	103	165	210	261	313	345	38
	42	90	146	192	234	290	327	42
	46	78	128	172	210	249	290	46
	50	67	116	152	186	231	260	50
54	64	110	140	174	192	242	54	
58							58	
60							60	
65	14							14
	16	275	400	515	580			16
	18	240	370	458	548			18
	20	218	316	418	502	560		20
	22	210	286	366	460	550		22
	24	190	270	336	416	486	575	24
	26	170	239	308	380	446	520	26
	28	157	224	284	351	410	473	28
	30	143	209	266	328	380	435	30
	34	120	185	236	288	343	389	34
	38	100	162	205	258	310	342	38
	42	93	143	188	230	274	319	42
	46	79	126	166	207	246	282	46
	50	66	115	148	185	228	255	50
54	61	106	137	171	209	238	54	
58	55	96	128	157	188		58	
60	50	85	119	145	174		60	
71	16	260	390	505				16
	18	232	368	445	540			18
	20	216	313	400	490	545		20
	22	205	283	365	450	530		22
	24	185	265	335	400	480		24
	26	168	238	306	375	440	518	26
	28	155	222	280	348	400	470	28
	30	141	205	264	324	375	430	30
	34	119	180	232	284	340	380	34
	38	98	160	200	254	305	340	38
	42	90	140	180	225	270	315	42
	46	76	123	162	203	243	278	46
	50	65	112	146	183	223	252	50
	54	60	100	134	168	205	234	54
	58	53	91	124	154	188	217	58
	62	44	86	112	140	172	200	62
64	34	73	97	127	150		64	
66							66	
68							68	
72							72	

## Lifting Capacities (t) on Maxi-Lift-Equipment

with 43 m Maxi-Lift Mast  
Outrigger base 14,7 x 14,7 m (360°)  
DIN-Ratings

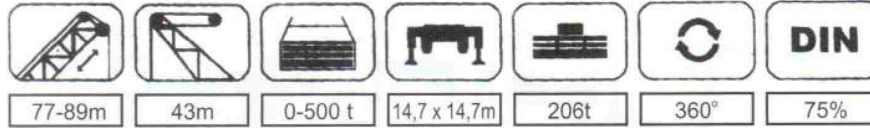

Hauptausleger Main Boom Fleche principale m		Maxi-Lift Counterweight						
		0T	100T	200T	300T	400T		500T
77	16							16
	18	225	365	410				18
	20	215	310	380				20
	22	200	280	365	415			22
	24	180	260	335	385			24
	26	166	237	305	370			26
	28	153	220	278	345			28
	30	140	200	262	320	370		30
	34	118	176	228	278	335		34
	38	97	157	196	250	300	337	38
	42	85	135	175	220	266	310	42
	46	74	120	158	200	240	272	46
	50	64	110	145	180	218	248	50
	54	58	97	130	166	200	230	54
	58	50	87	120	152	181	210	58
	62	42	79	110	138	170	195	62
64							64	
66	36	74	100	130	157	180	66	
68	32	70	94	124	148	172	68	
72	27	64	90	117	140		72	
83	18	220	360	400				18
	20	213	300	365				20
	22	198	280	352	400			22
	24	178	260	330	382			24
	26	164	233	304	360			26
	28	151	220	272	338			28
	30	140	200	260	318	360		30
	32							32
	34	119	174	226	276	310		34
	36							36
	38	97	154	195	246	296		38
	40	88	145	183	233	274	312	40
	44	77	123	163	206	253	285	44
	48	64	111	150	191	229	262	48
	52	57	100	136	170	206	237	52
	56	48	90	123	156	191	217	56
60	38	71	113	144	173	188	60	
64	32	73	103	131	160	175	64	
68							68	
70		63	90	118	142	160	70	
72							72	
76		52	83	108	139	147	76	
80							80	
89	18							18
	20	212	310	352				20
	22	196	276	340				22
	24							24
	26	163	236	302	350			26
	28							28
	30	140	200	256	315			30
	32	126	185	240	297	308		32
	34							34
	36	110	160	210	258	280		36
	38							38
	40	86	144	185	230	265	290	40
	44	74	123	162	203	250	280	44
	48	60	108	150	190	224	260	48
	52	50	97	135	170	203	230	52
	56	40	88	121	155	189	200	56
60	30	80	112	143	171	174	60	
64	25	70	100	128	158	168	64	
68	20	62	94	120	149	158	64	
70							70	
72		55	86	110	137	151	72	
76		50	80	105	128	140	76	
80		44	75	98	120		80	

## Lifting Capacities (t) on Maxi-Lift-Equipment

with 43 m Maxi-Lift Mast  
Outrigger base 14,7 x 14,7 m (360°)  
DIN-Ratings

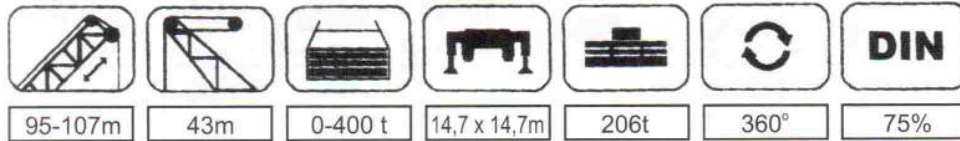

Hauptausleger Main Boom Fleche principale m		Maxi-Lift Counterweight					
		0T	100T	200T	300T	400T	
95	20	200	300				20
	24	160	270				24
	28	143	217	260			28
	32	120	179	238	288		32
	36	103	160	209	250		36
	40	82	138	184	226	272	40
	44	71	123	161	202	255	44
	48	58	107	149	188	230	48
	52	48	96	134	168	210	52
	56	39	85	120	154	190	56
	60	30	78	110	141	170	60
	64	25	69	99	126	163	64
	68	20	62	93	118	148	68
	72		54	85	109	135	72
	76		48	79	103	125	76
80		42	74	96	118	80	
84		36	68	90	110	84	
101	20						20
	24	155	260				24
	28	138	215	252			58
	32	115	180	236			32
	36	98	160	208	240		36
	40	79	136	183	223		40
	44	69	123	160	201		44
	48	56	106	148	186		48
	52	45	95	132	166		52
	56	38	83	118	152		56
	60	30	76	109	140		60
	64	25	68	98	124		64
	68	20	61	92	120		68
	72		53	84	108		72
	76		46	78	102		76
80		40	72	94		80	
84		33	67	88		84	
107	20						20
	24	150	250				24
	28	130	212	246			28
	32	110	180	235			32
	36	90	160	207	230		36
	40	76	135	182	218		40
	44	67	123	160	200		44
	48	55	105	147	185		48
	52	43	95	131	165		52
	56	37	80	117	150		56
	60	29	74	108	138		60
	64	25	67	97	122		64
	68	20	60*	90	115		68
	72		52	83	108		72
	76		45	77	100		76
80		38	70	92		80	
84		30	66	87		84	

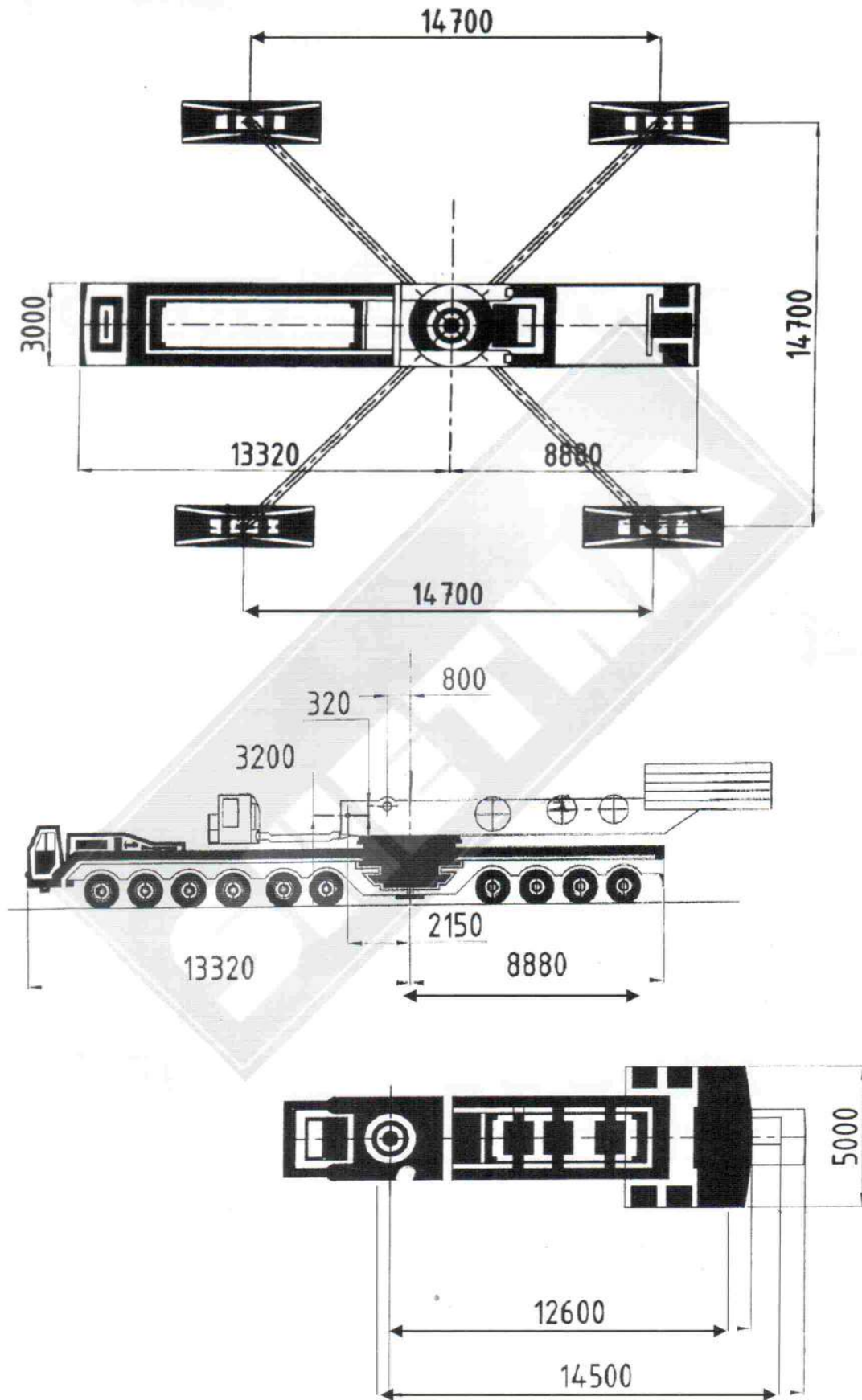

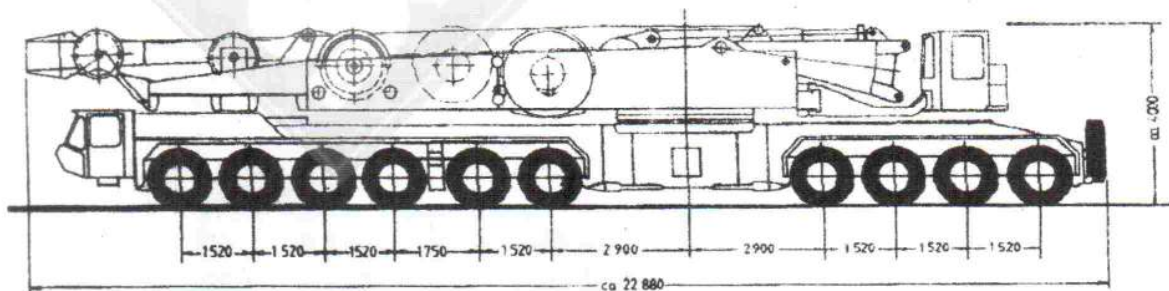
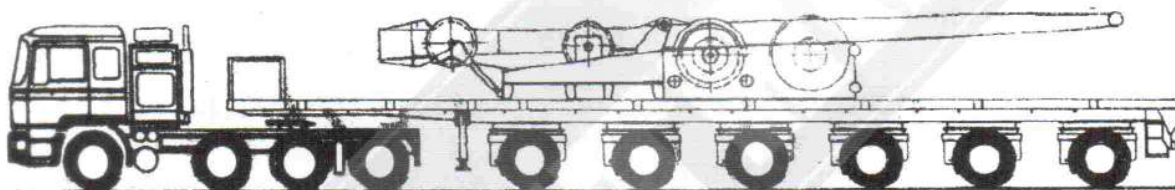
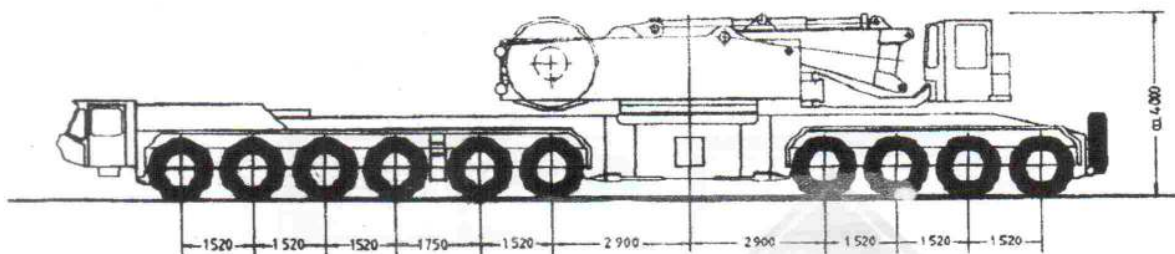

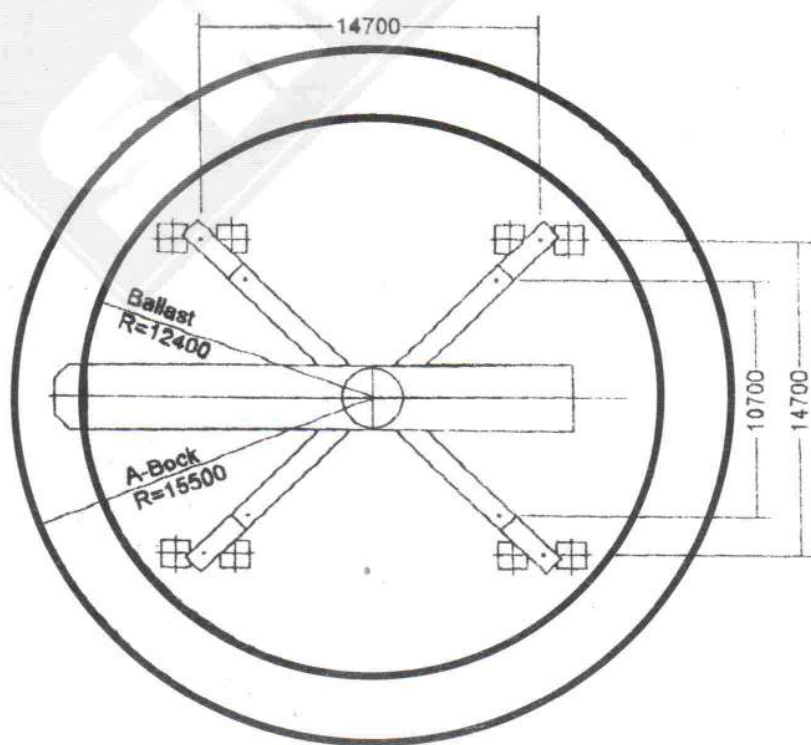
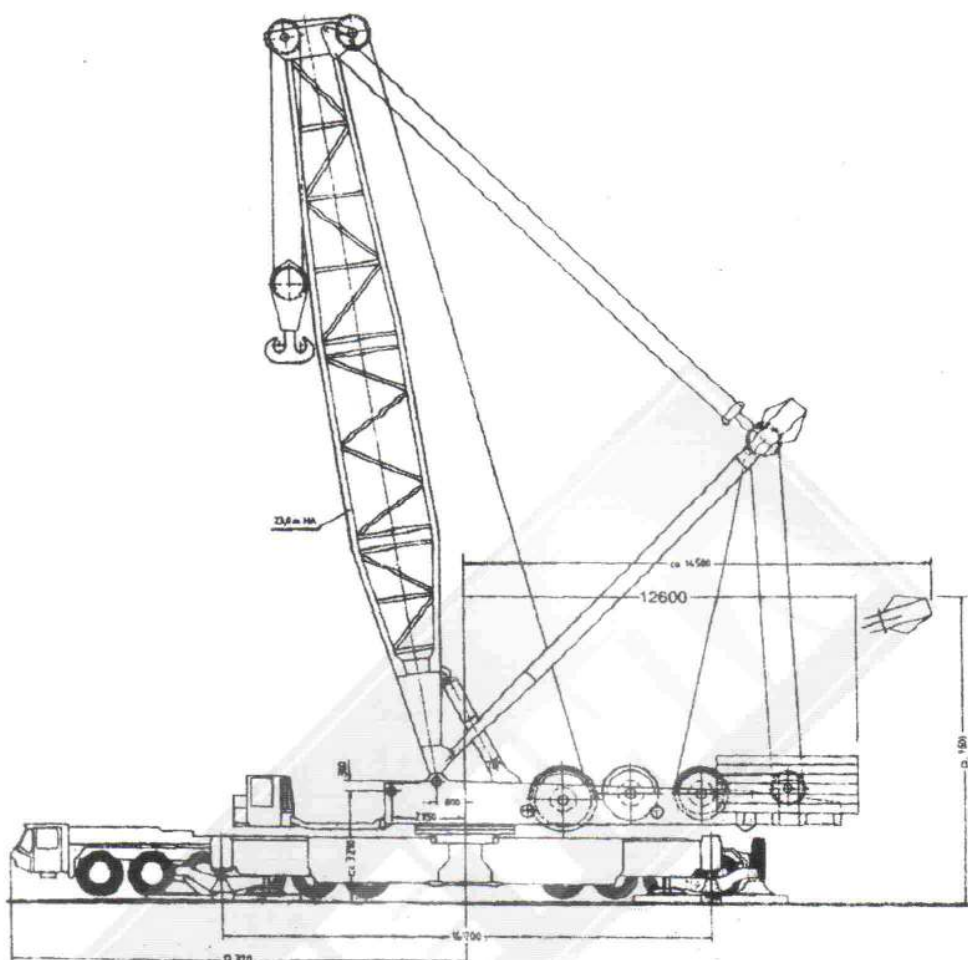

# GOTTWALD

AK850/1100



**GOTTWALD**

**SHETHIA**