

QUY180

Zoomlion QUY180 Crawler Crane ▶▶

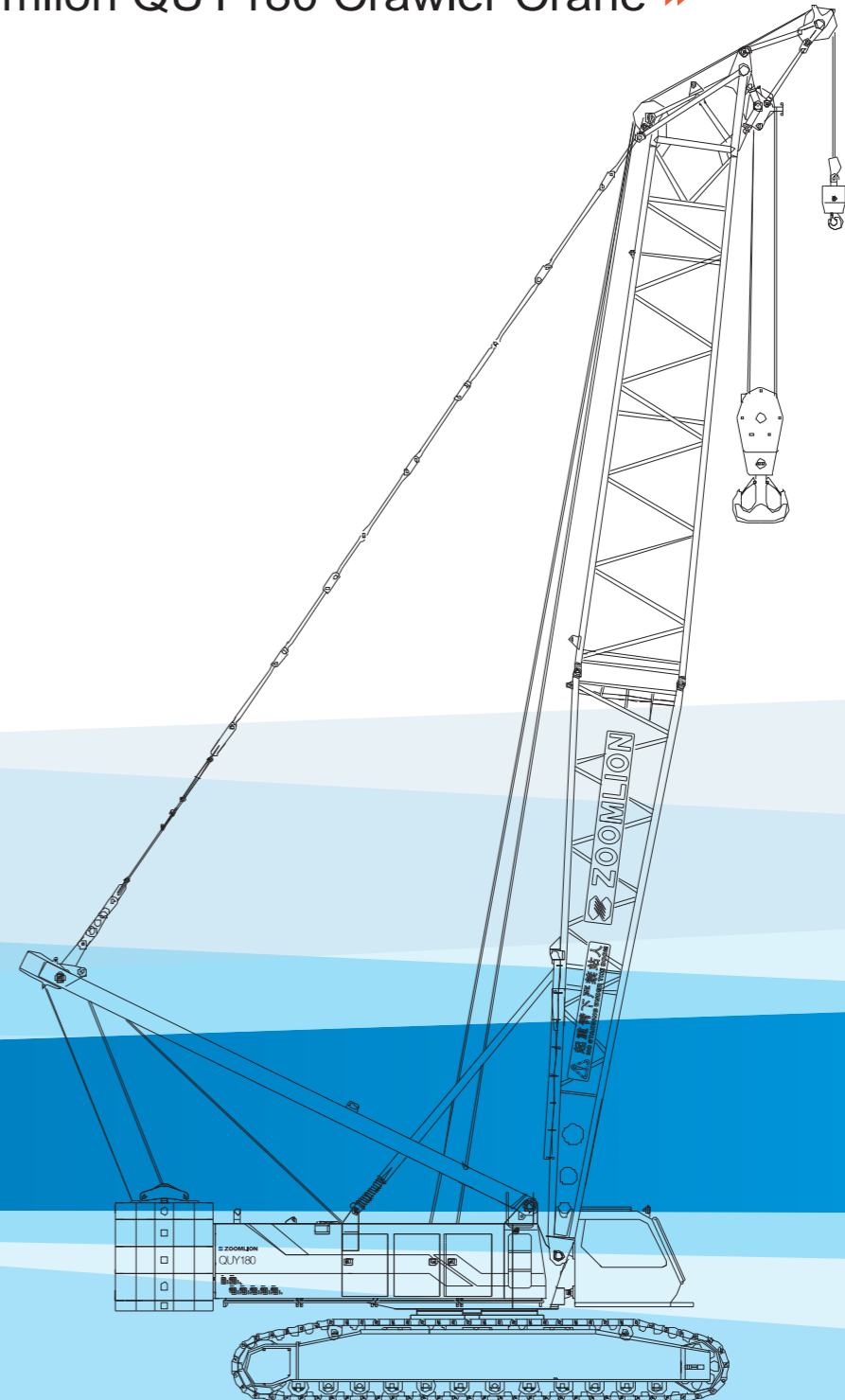

Contents

Vision Creates the Future

Expertise Heavy Industry Sci-Tech



I. External Dimensions and Main Parameters		
1. External Dimensions of Entire Crane, including Basic Boom	01	
2. Main Performance Parameters	02	
3. External Dimensions and Weight of Main Transport Components	03	
II. Technical Descriptions		
4. Boom System	08	
5. Mechanisms	09	
6. Systems	10	
7. Safety Devices	10	
8. Control Room	11	
9. Hook	11	
III. Description of Boom Assembly		12
IV. Self-Mounting and Dismounting Functions		13
V. Lifting Performance		
10. Lifting Characteristics of Standard Main Boom	15	
11. Lifting Characteristics of Light Duty Boom	18	
12. Lifting Characteristics of Main Boom + Fixed Boom	20	
13. Lifting Characteristics of Main Boom + Luffing Fly Jib	30	

I. External Dimensions and Main Parameters

1. External Dimensions of Entire Crane, including Basic Boom

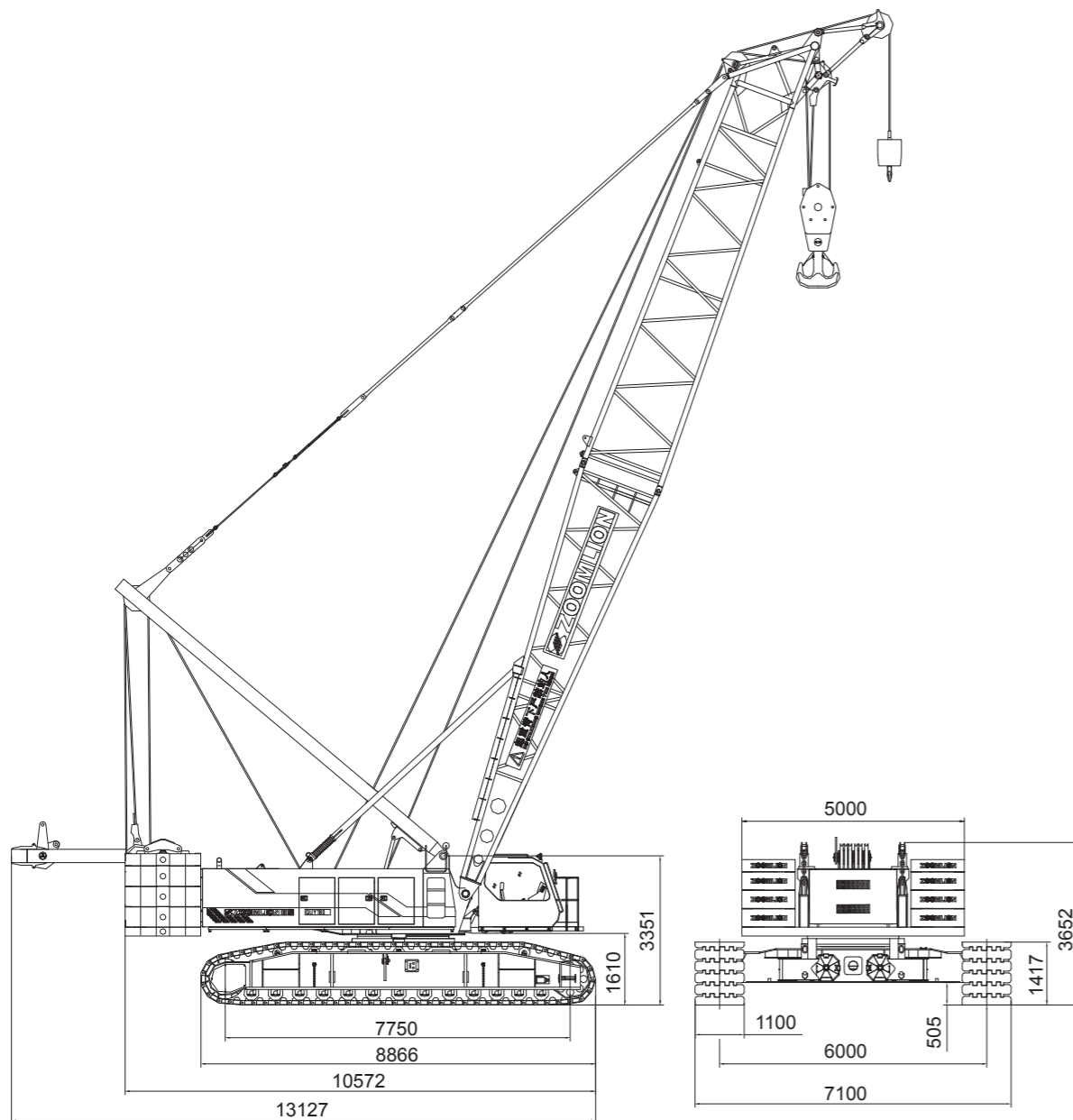

2. Main Performance Parameters

Items	Unit of measurement	Values	Remarks	
Maximum lifting capacity × radius	t × m	180 × 5		
Deadweight of crane with basic boom	t	167		
Length of main boom	Heavy duty boom	m	20~83	
	Light duty boom	m	86~92	
Length of fixed fly jib	m	13~31		
Maximum lifting capacity with fixed fly jib	t	25		
Setting angle of fixed fly jib	°	10, 30		
Maximum length of main boom + fixed fly jib	m	71 + 31	Length of main boom 47~71	
Length of luffing fly jib	m	24~51		
Maximum lifting capacity with luffing fly jib	t	38		
Working angle of main boom in crane operation with luffing fly jib	°	85, 75, 65		
Maximum length of main boom + luffing fly jib	m	56 + 51	Length of main boom 38~56	
Speed of single rope on drum	Primary lifting	m/min	110	Sixth layer of drum
	Secondary lifting	m/min	110	Sixth layer of drum
	Luffing	m/min	30	Fifth layer of drum
Swiveling speed	rpm	1.4		
Traveling speed	km/h	1.2		
Gradeability	%	30%		
Ground pressure	Mpa	0.1		
Overall dimensions L × W × H	m	10.6 × 7.1 × 3.65	Excluding mast boom	
Rated power/rotational speed	kW/rpm	227/2000	QSL9-C305	
Engine Maximum output torque/rotational speed	Nm/rpm	1505/1400		
Emissions standard		U.S. EPA Tier 3 and EU Stage III		
Distance between track centers × crawler contact length × crawler shoe width	mm	6000 × 7750 × 1100		

3. External Dimensions and Weight of Main Transport Components

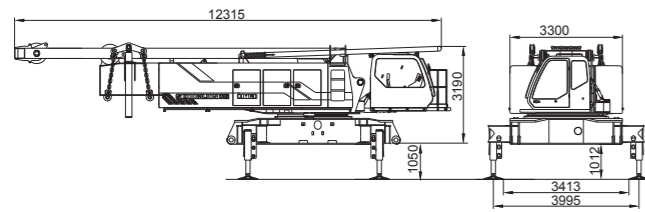

Name	Main machine
Weight (t)	43.5
Quantity	1
Remarks	

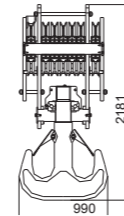

Name	Main hook 160t hook
Weight (t)	2.377
Quantity	1
Remarks	

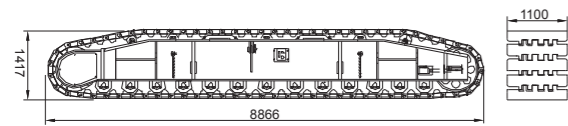

Name	Crawler assembly
Weight (t)	20.7
Quantity	2
Remarks	

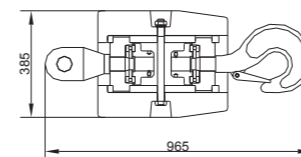

Name	Auxiliary hook 12t hook
Weight (t)	0.461
Quantity	1
Remarks	

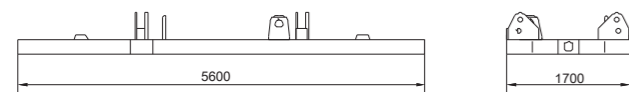

Name	Counterweight base
Weight (t)	13.75
Quantity	1
Remarks	

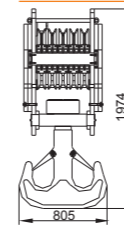

Name	Auxiliary hook 100t hook
Weight (t)	1.93
Quantity	1
Remarks	

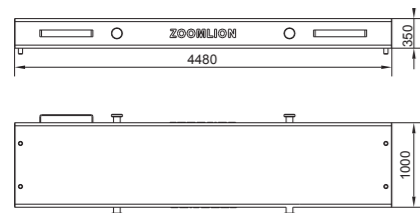

Name	Ballast weight of vehicle body
Weight (t)	10
Quantity	2
Remarks	

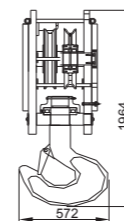

Name	Auxiliary hook 50t hook
Weight (t)	1.358
Quantity	1
Remarks	

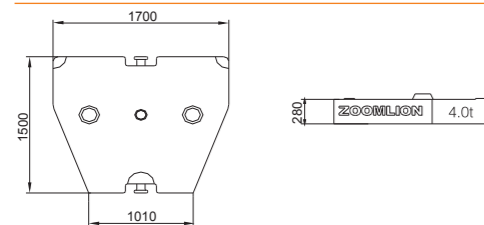

Name	Counterweight
Weight (t)	4
Quantity	2
Remarks	

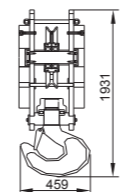

Name	Auxiliary hook 30t hook
Weight (t)	1.085
Quantity	1
Remarks	

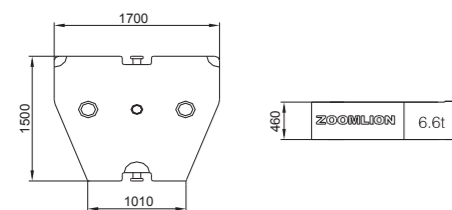

Name	Counterweight
Weight (t)	6.6
Quantity	6
Remarks	

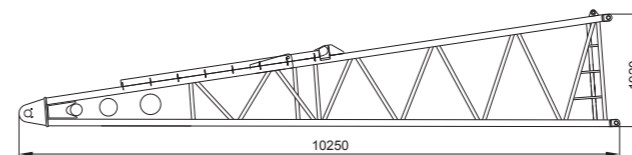

Name	Base section of main boom
Weight (t)	2.214
Quantity	1
Remarks	Width 2114

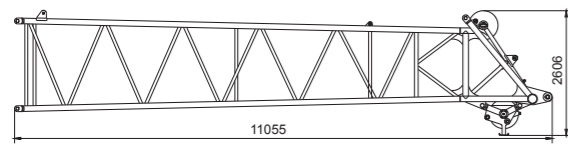

Name	Top section of main boom
Weight (t)	2.89
Quantity	1
Remarks	Width 2114

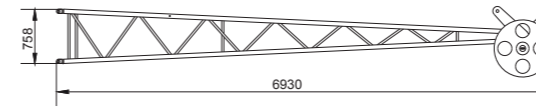

Name	Top section of fixed fly jib
Weight (t)	0.397
Quantity	1
Remarks	Width 960

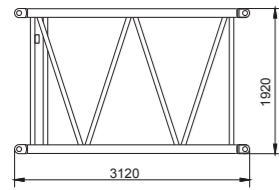

Name	3m section of main boom
Weight (t)	0.538
Quantity	1
Remarks	Width 2114

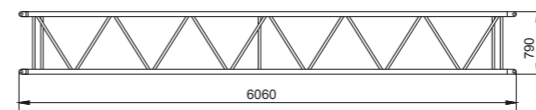

Name	6m section of fixed fly jib
Weight (t)	0.232
Quantity	3
Remarks	Width 960

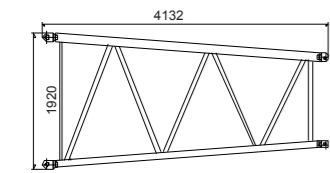

Name	Transition section of main boom 4m
Weight (t)	0.538
Quantity	1
Remarks	Width 1920

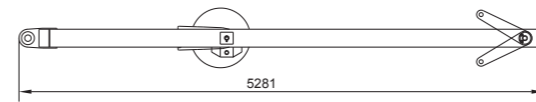

Name	Bracing pole of fixed fly jib
Weight (t)	0.473
Quantity	1
Remarks	Width 1457

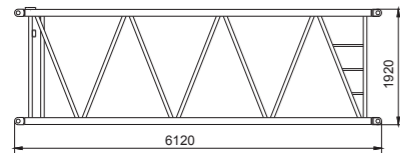

Name	6m section of main boom
Weight (t)	0.891
Quantity	1
Remarks	Width 2114

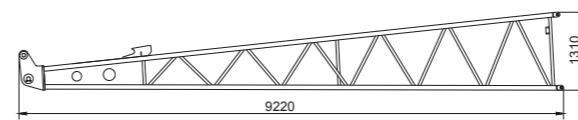

Name	Base section of luffing fly jib
Weight (t)	0.787
Quantity	1
Remarks	Width 1306

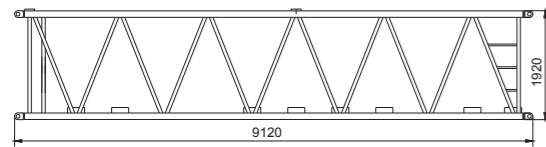

Name	9m section of main boom
Weight (t)	1.323
Quantity	6
Remarks	Width 2114

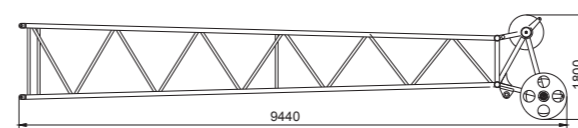

Name	Top section of luffing fly jib
Weight (t)	0.891
Quantity	1
Remarks	Width 1306

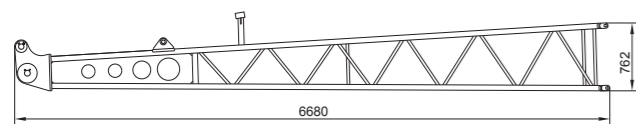

Name	Base section of fixed fly jib
Weight (t)	0.436
Quantity	1
Remarks	Width 1458

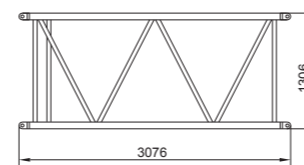

Name	3m section of luffing fly jib
Weight (t)	0.212
Quantity	1
Remarks	Width 1306

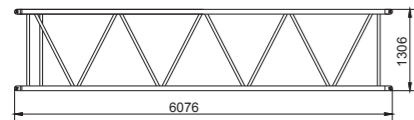

Name	6m section of luffing fly jib
Weight (t)	0.381
Quantity	2
Remarks	Width 1306

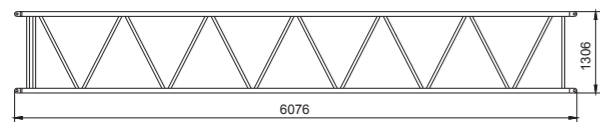

Name	9m section of luffing fly jib
Weight (t)	0.55
Quantity	2
Remarks	Width 1306

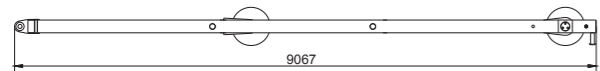

Name	Front bracing pole of luffing fly jib
Weight (t)	1.011
Quantity	1
Remarks	Width 1293

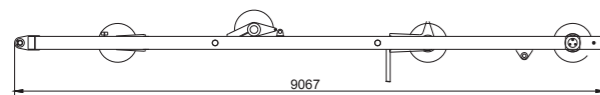

Name	Rear bracing pole of luffing fly jib
Weight (t)	1.222
Quantity	1
Remarks	Width 1631

II. Technical Descriptions

4. Boom System

The boom system is based on a truss-type structure and made with imported high strength tubings, with anchoring rods that are made of imported high strength plates.

Main boom
 Length of main boom: 20~83m
 Length of additional adjustable section of main boom: 3m, 6m, and 9m

Table of Main Boom Lengths Configuration Combinations

Length of main boom (m)	Intermediate section of main boom (piece)		
	3m section	6m section	9m section
20	0	0	0
23	1	0	0
26	2	0	0
29	1	1	0
32	2	1	0
35	1	2	0
38	1	1	1
41	2	1	1
44	1	2	1
47	1	1	2
50	2	1	2
53	1	2	2
56	1	1	3
59	2	1	3
62	1	2	3
65	1	1	4
68	2	1	4
71	1	2	4
74	1	1	5
77	2	1	5
80	1	2	5
83	1	1	6

Length of light duty boom: 86~92m

Table of Light Duty Boom Length Combinations

Length of main boom (m)	Intermediate section of main boom (piece)			
	Heavy duty boom (m)	Transition section (m)	Intermediate section of light duty boom (m)	Top section of light duty boom (m)
86	73	4	0	9
89	73	4	3	9
92	73	4	6	9

Fixed fly jib
 Length of main boom: 47m~71m
 Length of fixed fly jib: 13~31m
 Length of additional adjustable section of fixed fly jib: 6m
 Maximum length of main boom + fixed fly jib: 71 + 31m

Table of Fixed Fly Jib Length Combinations

Length of fixed fly jib (m)	Intermediate section of fixed fly jib (piece)
13	0
19	1
25	2
31	3

Luffing fly jib
 Length of main boom: 38m~56m
 Length of luffing fly jib: 24~51m
 Length of additional adjustable section of luffing fly jib: 3m, 6m, and 9m
 Maximum length of main boom + luffing fly jib: 56 + 51m

Table of Luffing Fly Jib Length Combinations

Length of luffing fly jib (m)	Intermediate section of luffing fly jib (piece)		
	3m section	6m section	9m section
24	0	1	0
27	1	1	0
30	2	1	0
33	1	2	0
36	1	1	1
39	2	1	1
42	1	2	1
45	1	1	2
48	2	1	2
51	1	2	2

5. Mechanisms

Primary and secondary lifting mechanisms

These mechanisms are both comprised of a variable displacement axial plunger hydraulic motor, balance valve, speed reducer, normally closed brake, and wire ropes; they can be controlled independently of other mechanisms.

The wire ropes used are completely non-rotating and anti-twisting wire ropes, imported from Germany.

The primary and secondary lifting mechanisms are dual speed, offering two different lifting speeds to improve operational efficiency.

	Wire rope diameter	26mm
Main winch	Wire rope length	Main winch 380m
		Auxiliary winch 380m
Auxiliary winch	Single rope speed (6th layer)	0~110m/min
	Single rope tension	135kN

Luffing mechanism

The luffing mechanism is comprised of an internal axial plunger hydraulic motor, balance valve, speed reducer, normally closed brake, and wire ropes; it can be controlled independently of other mechanisms.

The wire ropes used are completely non-rotating and anti-twisting wire ropes, imported from Germany.

	Drum diameter	540mm
	Operating speed of the outermost layer	35m/min × 2
Luffing winch	Wire rope diameter	Φ26mm × 2
	Wire rope length	140m × 2
	Single rope tension	122.5kN

Slewing mechanism

The slewing mechanism is comprised of an internal variable displacement axial plunger hydraulic motor, gear speed reducer, slewing brake valve, brake, pinions and slewing bearings; the pinion-driven slewing bearing allows for full 360° slewing movements, thereby providing slewing functionality to the upper machinery.

The slewing mechanism is equipped with a controllable slip-turn function to reduce shock and allow for higher stability during initiation and braking.

The slewing mechanism employs triple-row roller external geared slewing bearings and a slewing speed reducer to provide stronger carrying capacity and high precision, thereby ensuring slewing stability and accuracy.

The slewing mechanism offers stepless speed regulation within the range of 0~1.4 r/min.

The slewing mechanism is mechanically lockable through the locking device that is located at the front of the rotating platform.

Traveling mechanism

The traveling mechanism is a dual-motor, dual-reducer type; the hydraulic motor, traveling speed reducer and balance valve are all imported products. The two crawlers are controlled by two different control handles, allowing for a variety of traveling actions such as straight line traveling, unilateral steering, differential steering, pivotal steering, driving with load, etc., thus offering a high level of mobility, maneuverability and flexibility.

Traveling speed: 0~1.2km/h

Gradeability: 30%

Crawler tensioning: crawlers are tensioned through jacks, making adjustment is fast, easy and reliable.

Mast jack-up mechanism

Comprised of the mast, mast jack-up oil cylinder, auxiliary hydraulic system, etc, this mechanism is used during self-assembling/disassembling (or relocating) of the whole machine, where the mast is jacked up beyond 90 degrees perpendicular from its horizontal position to make it easy to connect the anchoring rods, assemble the boom, and mount the crawler assembly and counterweight.

Control room swiveling and luffing mechanism

The control room can rotate 90° from the side of the rotating platform to the front of the rotating platform and be fixed there using locating pins, thus reducing the width of the overall crane and facilitating transport.

The control room's luffing is controlled with oil cylinders; when lifting to a especially high height, the control room can luff upwards by 20°, thereby dramatically expanding the driver's field of vision.

Counterweight and counterweight loading/unloading mechanism

This mechanism is comprised of a counterweight base plate, counterweight, counterweight jack-up oil cylinder, load bearing chain, and fixing pin oil cylinder. It allows for the self-mounting and dismounting of the counterweight, thereby improving the crane's utility and reducing the risks involved in manual installation.

Outrigger lifting and crawler self-mounting and dismounting mechanism

The outrigger jack-up and crawler self-mounting and dismounting mechanism is comprised of the undercarriage outriggers, outrigger oil cylinders, outrigger valves, and crawler power pin, etc.

The outrigger jack-up mechanism is the primary load carrying mechanism during the crawler self-mounting and dismounting process.

The crawler self-mounting and dismounting mechanism lifts and installs the crawler assembly using the mast and mast jack-up mechanism, and uses the power pin to connect the chassis frame and the crawler assembly together.

When no auxiliary lifting equipment is available, the outrigger jack-up and crawler self-mounting and dismounting mechanism can independently mount and dismount the crawler assembly, thereby improving operational efficiency and reducing the manual work intensity, while the power pin can help avoid the risks involved in manual control.

6. Systems

Hydraulic system

The hydraulic system is comprised of a main pump, control valve, hydraulic motor, hydraulic oil tank, cooler, etc.

The hydraulic system employs one of the world's most advanced load sensing systems, and imported products are used for all major components such as the pump, motor, and main return valve to help save energy, ensure high efficiency, high reliability, and long service life.

Main hydraulic pump: the load sensing pump is connected to the engine through the transfer box.

Oil source for auxiliary mechanisms: gear pump.

Main control valve: electrohydraulic proportional control valve.

Main circuit control method: variable displacement valve + main directional control valve of the variable displacement main pump, which is centrally controlled by two control handles.

Control of auxiliary mechanisms: multi-directional solenoid valve block.

Outrigger control: multi-directional solenoid valve block operated from the electric control box.

Capacity of hydraulic oil tank: 1000L.

Oil filter: discharge oil filter, the precise filter for oil circuit control.

Cooler: aluminum radiator, powered by the hydraulic motor.

Various overflow valves in the hydraulic system can effectively prevent local systems or the whole system from overloading, and protect all system components to ensure their safe operation.

Electrical system

DC 24V, negative ground, 2 × 195AH batteries.

The electrical components of the vehicle primarily include: power supply, engine starter, engine misfiring, indicator lights, alarms, lighting devices, fans, windshield wipers, horn, lifting height limiters, hydraulic oil cooling fans, digital display monitor, PLC controller, engine preheater, safety devices, etc.; these appliances ensure that the crane will operate safely and provide a comfortable working environment for the driver and other workers.

The whole vehicle employs CAN bus technology, which connects the engine, PLC controller and digital display together with fault detection and self-diagnosis functions. GPS/GPRS global positioning system (optional) and fault diagnosis system.

Power system

The engine is an original imported US Cummins electronic injection diesel engine.

Rated output power/rotational speed: 227kw/2000rpm

Maximum output torque/rotational speed: 1505Nm/1400rpm

Emissions standard: U.S. EPA Tier 3 and EU Stage 3

For the fuel tank, a large-volume 700L tank is used to ensure a sufficiently long working time of the engine.

Digitalized display system

The 10.4 in. LCD monitor, with multi-language display capabilities, can centrally display the various operating mode signals collected by the PLC controller, including the engine's rotational speed, water temperature, engine oil pressure, hydraulic pump pressure, main motor pressure, the level of main machine operation, and the working conditions of the I/O monitor, etc. It can monitor working conditions in realtime; when the crane is working abnormally, the system will emit a yellow or red light alarm, and will also sound an audible alarm in the case of a red alarm.

Centralized lubrication system

Two sets of centralized lubrication systems are adopted (one for the upper machinery, and one for the undercarriage) to dramatically reduce the wear and tear on parts and components and are easy to maintain.

7. Safety Devices

This crane adopts multiple types of safety and alarm devices, including mechanical, electronic, and hydraulic, to ensure safe operation of the machine.

Load moment limiter

The limiter is comprised of a load moment indicator and a digital LCD monitor. When the lifting load moment reaches 90% of the rated load moment, an alarm lamp will light up and a buzzer alarm will sound; operation of the crane will stop automatically when the lifting load moment reaches the rated load moment in order to prevent any incidents that may occur as a result of crane overloading during construction operations, thus helping to ensure normal and safe operation of the crane.

The digital LCD monitor can display the following data:

- Moment ratio
- Main boom elevation angle
- Length of main boom
- Working radius
- Actual hook load
- Allowed lifting load
- Maximum allowed lifting height
- Wind speed at top of boom

Various overflow valves in the hydraulic system

Can suppress abnormally high pressures in the circuit, preventing damage to the hydraulic oil pump and motor, and preventing system overload.

Height limiter devices

The limit switch, movement weight and other components are mounted on the top section boom, and are used to prevent excessive lifting of the hook. When the hook is lifted to a certain height, the limit switch signals the electrical system to automatically stop the lifting of the hook, also setting off an acoustooptic warning through the buzzer and display screen in the control room to prevent overwinding of the hook.

Angle indicator

The boom angle indicator is located along the lower rear part of the boom's bottom section (right side of control room), allowing the driver convenient, clear visibility of the elevation angle of the boom from the control room.

Working boom limiting position alarm and protection system

This protection system has a load moment limiter and limit switch for dual-level control, enabling automatic termination of luffing movements of the boom's limited elevation angle position, while also simultaneously triggering an acoustooptic warning.

Boom overturn protection device

The brace poles, which are of a nested steel tube and spring structure, are mounted at the base section of the main boom; they employ spring-loaded compression force to provide support and to prevent the main boom from overturning.

Whole machine level sensor

This electronic level meter displays in realtime the inclination angle of the whole machine and sends an alarm to the digital display screen in order to ensure safe operation of the vehicle.

Hook safety latch

This device prevents the load from unhooking when lifting heavy loads.

Luffing winch ratchet locking mechanism

The luffing winch ratchet locking mechanism prevents luffing decline when the vehicle is parked for long periods of time.

Wire rope overwinding and over-release protection device

When the wire rope in the drum has been released until only three single wound coils remain, this protection device signals the electrical system to automatically cut off the releasing of rope and the descending hook, also setting off an acoustooptic warning through the buzzer and display screen in the control room.

Emergency stop button

In case of emergency, press this button to switch off the engine and stop all operations.

Wind speed indicator

The electronic wind speed sensor can indicate wind speed levels on digital display screen in realtime, conveniently alerting workers of potentially dangerous working conditions.

Tri-color warning light

With three different colors, red, yellow and green, the warning light can synchronously indicate overload status. Green indicates that the load factor is below 90%, yellow informs operators that the load factor is between 90% and 100%, while the red color warns that the load factor has exceeded 100% and that the crane is in danger of overloading.

Monitoring system (optional)

This system includes two cameras for monitoring conditions at the rear of the winch mechanism and of the whole machine. Monitor: with the press of a button you can toggle between different monitoring feeds.

Remote GPS monitoring system (optional)

This system allows for GPS satellite positioning, GPRS data transmission, equipment use status inquiry, statistical information and other functions.

8. Control Room

The structure of the control room is made entirely of steel, is surrounded by reinforced glass on all four sides, and has laminated glass for its sunroof and windshield. The interior is equipped with a sun shield on the right side, an adjustable seat, windshield wipers, an electronic control handle, air conditioning devices, load moment indicators, digitalized monitor, various switches, auxiliary remote control box operating assembly, electric fans, illuminating lamps, a CD player (DVD player optional), cigarette lighters, and fire extinguishers, etc. The control room offers a wide field of vision, and a spacious and comfortable interior that fully demonstrates the ergonomic design principles. During load lifting operations, the entire control room (driver's cab) can luff upwards with button controls, thereby expanding the driver's field of vision. The elevation angle ranges between 0~20°

9. Hook

- 160t main hook: equipped with 7 pulleys.
- 100t auxiliary hook: equipped with 4 pulleys.
- 50t auxiliary hook: equipped with 2 pulleys.
- 30t hook: equipped with 1 pulley.
- 12t hook: without pulley.

III. Description of Boom Assembly

Descriptions of Boom Assembly Codes

Code	Type	Operation mode parameters
S	Standard main boom	S=20m~83m
SL	Light duty boom	S=86m~92m
SF	Fixed fly jib	S=47m~71m F=13m~31m
SW	Luffing fly jib	S=38m~56m W=24m~51m

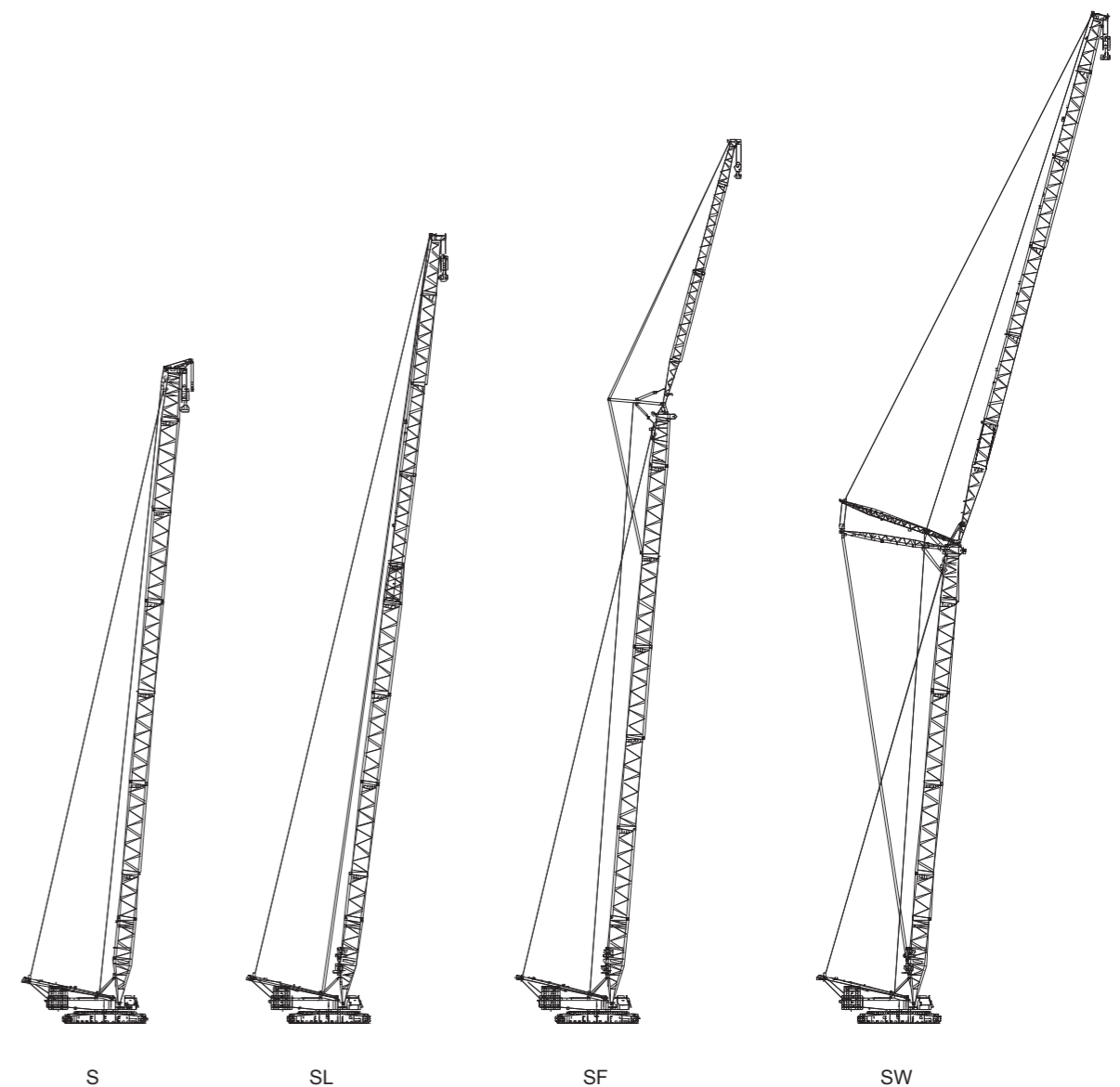

IV. Self-Mounting and Dismounting Functions

(Taking the self-mounting process of the crane operation with luffing fly jib as an example)

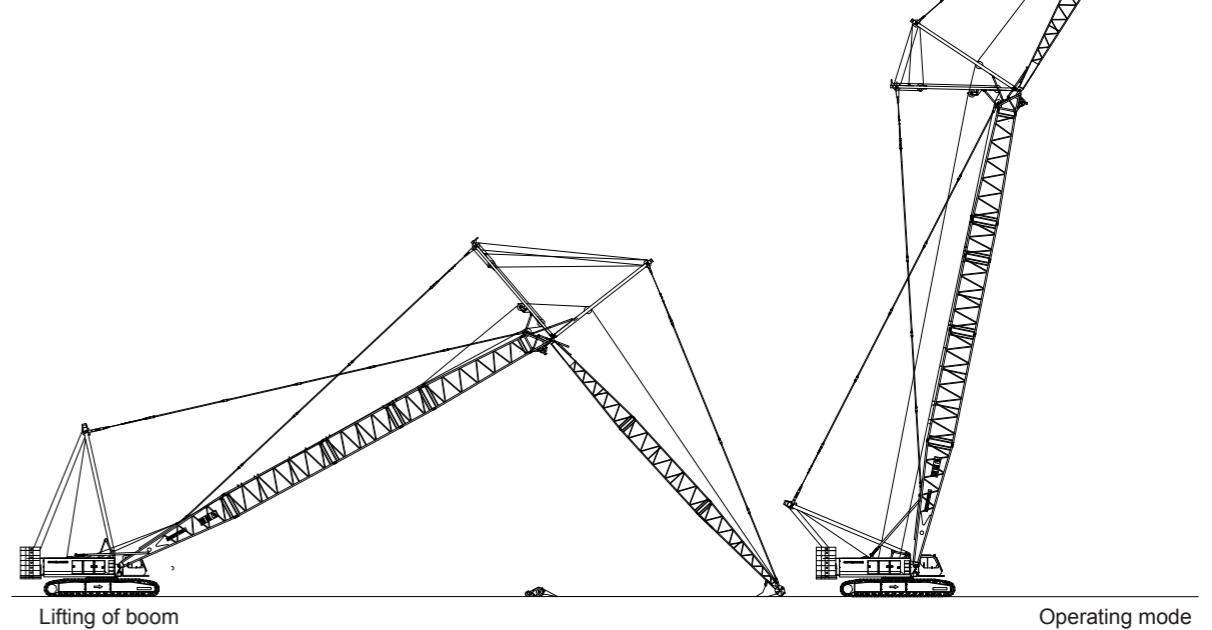
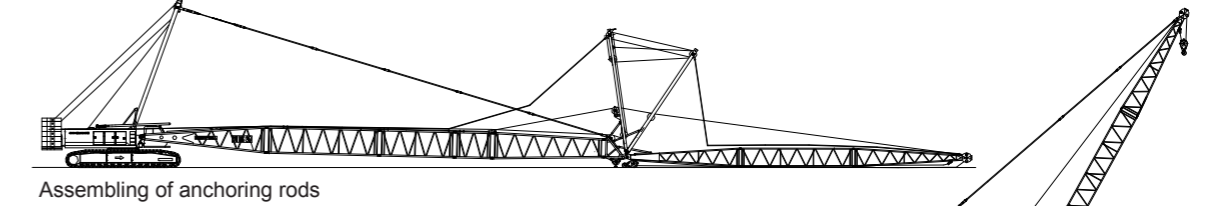
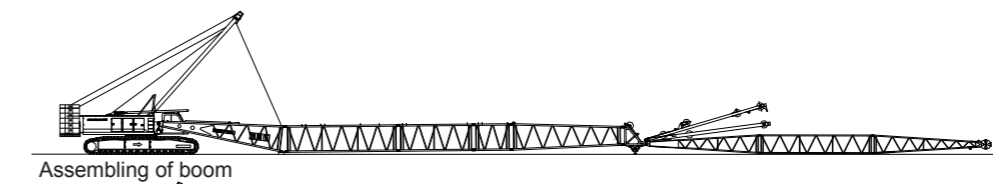
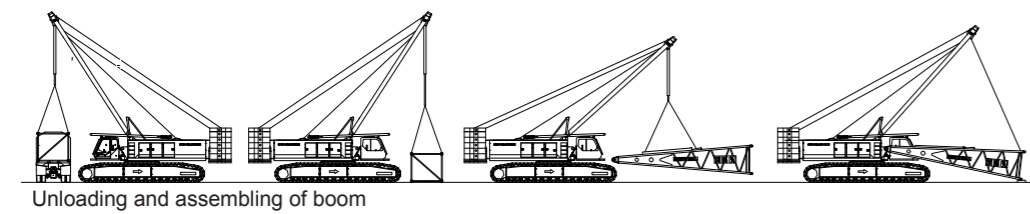
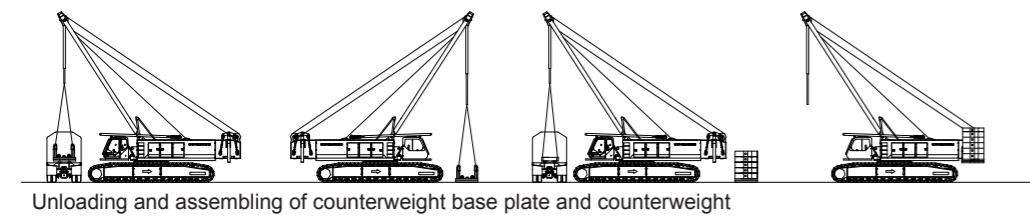
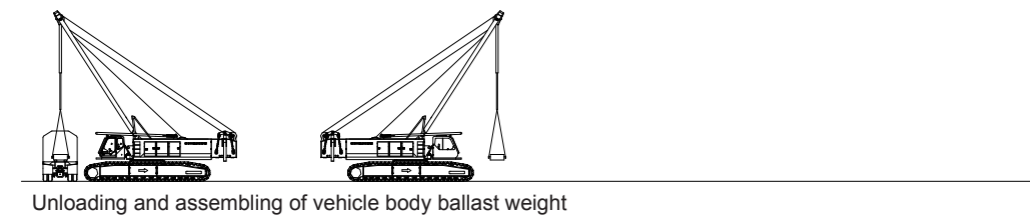
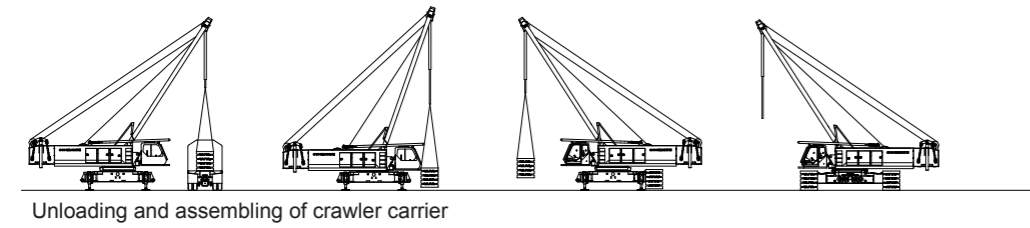
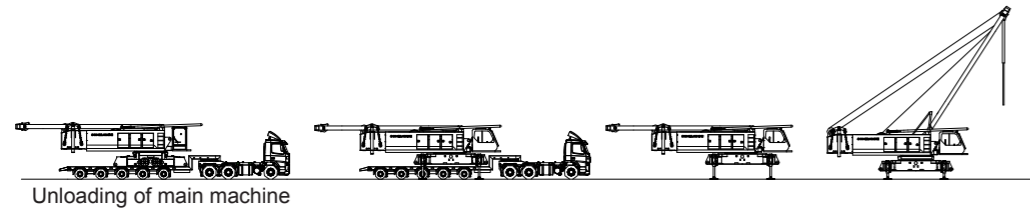

V. Lifting Performance

10. Lifting Characteristics of Standard Main Boom

Standard Main Boom Lifting Height Characteristics Curve

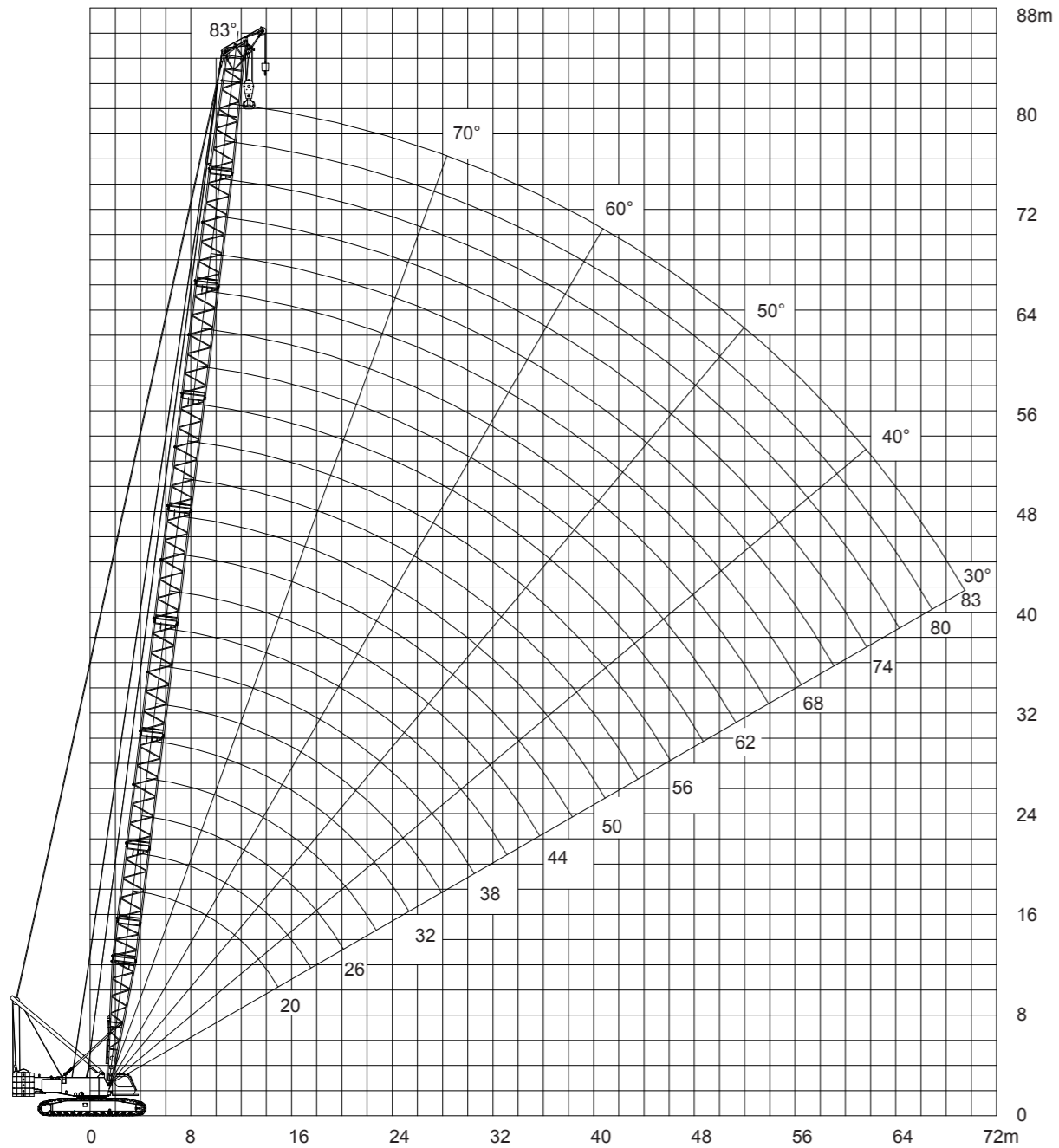

Table of Main Boom Lifting Performance (I)

Unit of measurement: t

Radius (m)	Boom length (m)											
	20	23	26	29	32	35	38	41	44	47	50	
5	180.0											
6	161.0	143.0	134.6									
7	146.0	141.0	132.8	130.8	122.0							
8	132.8	130.8	129.8	125.8	120.8	110.5	99.0					
9	114.8	114.8	111.8	108.8	105.8	102.8	98.7	90.3	87.3			
10	98.2	98.2	98.2	96.1	93.5	91.2	88.8	87.5	84.3	75.7	74.0	
11	85.3	85.3	85.3	85.3	83.5	81.7	79.7	77.8	75.9	74.3	72.5	
12	75.3	75.3	75.3	75.3	75.3	73.9	72.2	71.6	69.0	67.6	66.1	
13	67.3	67.3	67.3	67.3	67.3	67.3	66.0	64.5	63.1	61.9	60.6	
14	60.7	60.7	60.7	60.7	60.7	60.7	60.6	60.4	58.1	57.1	55.9	
15	52.7	52.7	52.7	52.7	52.7	52.7	52.7	54.9	53.8	52.9	51.8	
16	50.8	50.8	50.8	50.8	50.8	50.8	50.8	50.7	50.0	49.2	48.2	
17	46.8	46.8	46.8	46.8	46.8	46.8	46.8	46.8	46.6	46.0	45.1	
18	43.6	43.6	43.6	43.6	43.6	43.6	42.2	43.3	43.1	43.1	42.2	
19		40.5	40.5	40.5	40.5	40.5	30.4	40.3	40.7	40.1	39.7	
20		37.9	37.9	37.9	37.8	37.8	37.8	37.6	37.5	37.4	37.3	
22			33.4	33.4	33.3	33.3	33.3	33.1	33.0	32.9	32.8	
24			30.8	29.8	29.7	29.7	29.6	29.5	29.3	29.3	29.1	
26				26.3	26.6	26.6	26.6	26.5	26.3	26.3	26.1	
28					24.1	24.1	24.1	24.0	23.8	23.8	23.6	
30					23.4	22.1	21.9	21.8	21.6	21.6	21.4	
32						20.9	20.0	19.9	19.8	19.7	19.6	
34							17.9	18.3	18.1	18.1	17.9	
36								16.8	16.7	16.7	16.5	
38									16.3	15.4	15.2	
40										14.3	14.1	
42											13.1	
44												12.1

Table of Main Boom Lifting Performance (II)

Unit of measurement: t

Radius (m)	Boom length (m)										
	53	56	59	62	65	68	71	74	77	80	83
11	63.8	63.4									
12	63.8	63.2	61.8	51.7							
13	59.3	58.0	56.9	51.7	51.1						
14	54.7	53.6	52.6	51.5	49.8	45.8	41.7				
15	50.8	49.7	48.9	47.9	46.9	44.7	41.4	38.0	34.6		
16	47.3	46.3	45.5	44.6	43.8	42.9	40.1	36.6	33.9	31.4	27.1
17	44.2	43.3	42.6	41.8	40.9	40.1	39.4	35.7	33.2	30.6	25.1
18	41.5	40.6	40.0	39.2	38.4	37.7	37.0	34.7	32.3	29.7	23.9
19	39.0	38.2	37.6	36.9	36.2	35.4	34.8	33.4	31.4	28.9	23.8
20	36.8	36.0	35.5	34.8	34.1	33.4	33.2	32.2	30.5	28.1	23.1
22	32.6	32.3	31.8	31.1	30.5	29.9	29.7	29.0	28.5	26.6	22.7
24	29.0	28.8	28.7	28.1	27.5	26.9	26.5	26.1	26.0	24.1	21.7
26	25.9	25.7	25.7	25.5	25.0	24.4	24.0	23.9	23.8	22.7	21.5
28	23.4	23.2	23.1	22.9	22.7	22.2	21.9	21.7	21.5	21.3	19.7
30	21.2	21.0	21.0	20.8	20.6	20.3	20.0	19.5	19.3	19.1	18.1
32	19.4	18.2	19.1	18.9	18.7	18.5	18.3	17.9	17.8	17.6	17.2
34	17.8	17.5	17.5	17.3	17.1	16.9	16.7	16.4	16.3	16.2	15.6
36	16.3	16.1	16.0	15.8	15.6	15.4	15.3	15.1	15.0	14.3	14.1
38	15.1	14.8	14.8	14.6	14.4	14.1	14.0	13.8	13.6	13.3	12.9
40	13.9	13.7	13.6	13.4	13.2	13.0	12.9	12.7	12.5	12.1	11.6
42	12.9	12.7	12.6	12.4	12.2	12.0	11.9	11.7	11.5	11.3	11.1
44	12.0	11.8	11.7	11.5	11.3	11.1	11.0	10.7	10.5	10.2	10.1
46	11.1	10.9	10.9	10.6	10.5	10.2	10.1	9.9	9.7	9.3	9.1
48	10.6	10.1	10.1	9.9	9.7	9.5	9.4	9.1	8.9	8.1	7.8
50		9.3	9.4	9.2	9.0	8.8	8.7	8.4	8.2	7.4	7.1
52			8.4	8.5	8.3	8.1	8.0	7.8	7.6	6.8	6.5
54				7.9	7.7	7.5	7.4	7.2	7.0	6.2	5.9
56				7.6	7.2	7.0	6.9	6.7	6.4	5.6	5.4
58					6.8	6.5	6.4	6.1	5.9	5.0	4.8
60						6.0	5.9	5.7	5.5	4.5	4.3
62							5.4	5.2	5.0	4.1	3.9
64							5.1	4.8	4.6	3.7	3.4
66								4.3	4.2	3.3	3.0
68									2.9	2.9	2.7
70										2.6	2.3
72											2.0

11. Lifting Characteristics of Light Duty Boom

Light Duty Boom Lifting Height Characteristics Curve

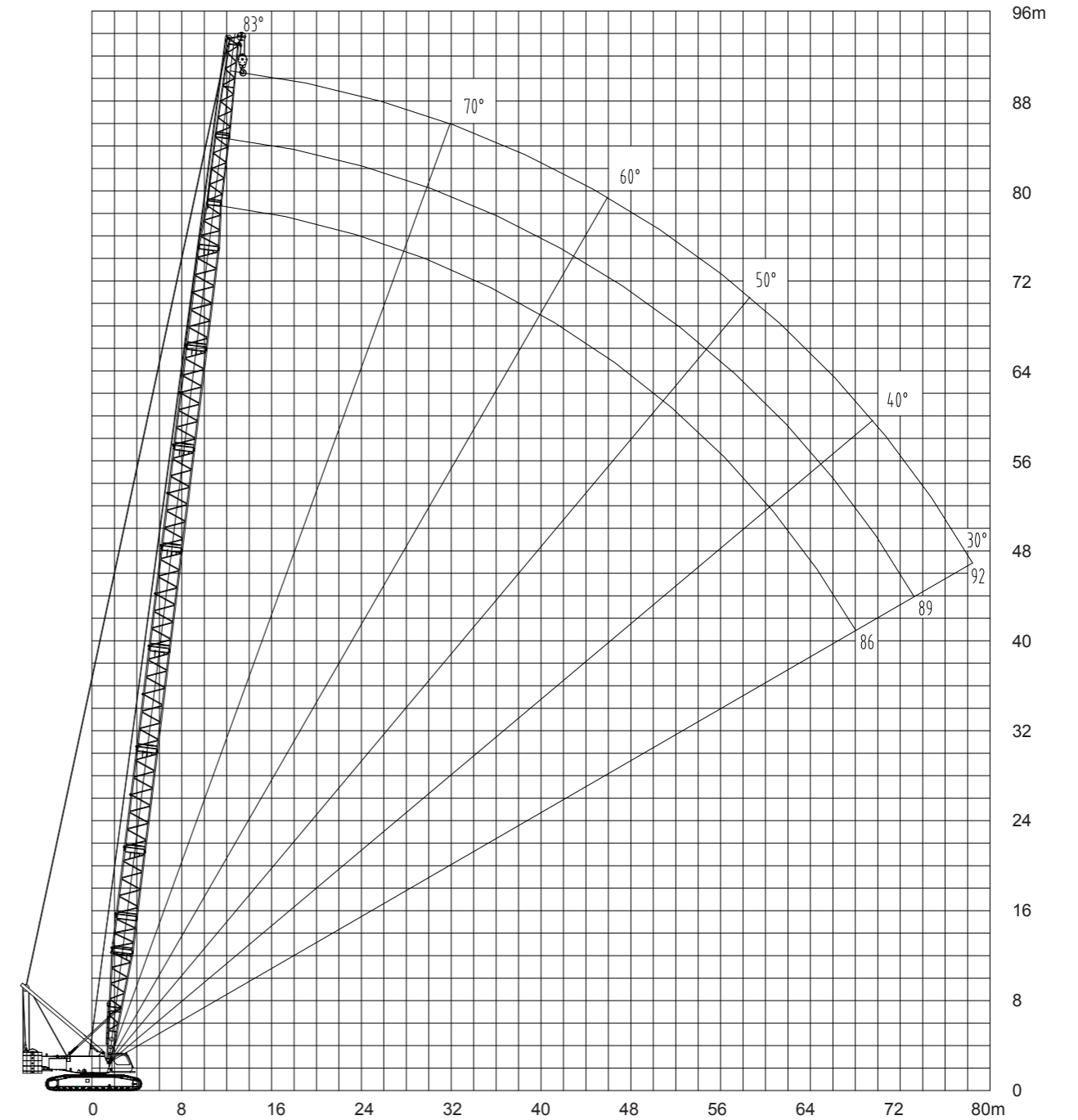

Table of Light Duty Boom Lifting Performance

Unit of measurement: t

Radius (m)	Boom length (m)		
	86	89	92
18	19.5	17.7	
20	19.4	16.8	15.6
22	18.1	16.0	14.8
24	17.6	15.5	14.1
26	17.0	15.0	13.4
28	16.4	14.3	12.9
30	15.0	13.7	12.5
32	13.8	13.2	11.9
34	12.6	12.1	11.5
36	11.6	11.1	10.7
38	10.6	10.2	10.2
40	9.7	9.5	9.4
42	9.0	8.8	8.7
44	8.3	8.1	8.0
46	7.6	7.5	7.4
48	7.0	6.8	6.8
50	6.4	6.2	6.2
52	5.9	5.7	5.7
54	5.5	5.3	5.2
56	5.0	4.8	4.7
58	4.6	4.4	4.3
60	4.2	4.0	3.9
62	3.8	3.6	
64	3.5	3.3	
66	3.3		
68	2.9		

Notes:

1. The actual lifting capacity is equal to the rated lifting capacity values listed in the table minus the weights of all slings, including the lifting hook, etc;
2. The rated lifting capacity as shown in the diagram is equal to the value of the load being lifted on a level, firm surface;
3. During crane operation with gooseneck boom (auxiliary fly jib), the lifting capacity is equal to the lifting capacity of the main boom at the same radius, but must not exceed a maximum of 12 tons.

12. Lifting Characteristics of Main Boom + Fixed Boom

Fixed Fly Jib Lifting Height Characteristics Curve

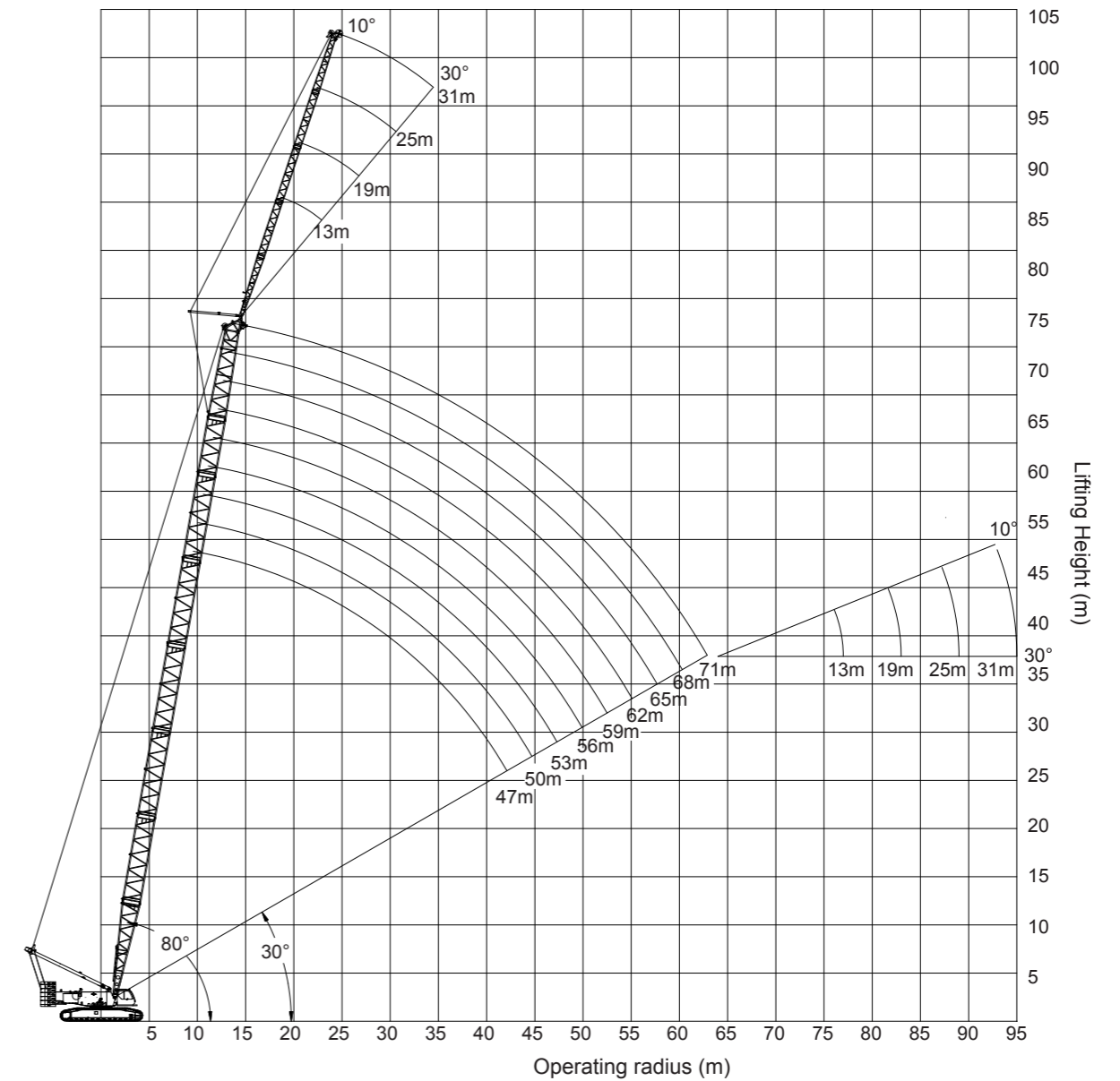

Notes:

1. The working radius is shown along the horizontal axis, the lifting height is shown along the vertical axis, and unit of measurement is meter (unit: m).
2. The working length of the main boom during crane operations with fixed fly jib is 47~71m, and the working length of the fixed fly jib is 13~31m.

Table of Fixed Boom Lifting Characteristics (I)

Unit of measurement: t

Length of main boom (m)	47							
	13		19		25		32	
	Jib set angle (°)							
Radius (m)	10	30	10	30	10	30	10	30
14	25							
16	24.5		20.7		11.7		8.0	
18	23.7		20.2		11.6		7.6	
20	22.7	19.8	19.7		11.5		7.4	
22	21.6	19.4	19.2	13.2	11.4		7.3	
24	20.5	18.7	18.8	13.1	11.2	7.8	7.1	
26	19.5	17.8	17.8	12.9	11.1	7.5	6.8	
28	18.6	17.1	16.9	12.7	11.0	7.3	6.4	
30	17.9	16.0	15.9	12.4	10.9	7.1	6.1	4.2
32	17.1	15.1	15	12.2	10.8	6.9	5.8	4.0
34	16.3	13.9	14.1	11.8	10.6	6.7	5.5	3.9
36	15.5	12.7	13.1	11.4	10.2	6.7	5.2	3.9
38	14.4	12.2	12.2	11.0	9.8	6.5	4.9	3.8
40	13.3	11.6	11.7	10.4	9.5	6.3	4.7	3.7
42	12.2	10.8	11.5	9.7	9.2	6.2	4.5	3.6
44	11.4	9.8	11.3	8.8	8.4	6.1	4.3	3.6
46	10.6	8.8	10.3	7.9	7.5	6.0	4.1	3.5
48	9.9	8.0	10.3	7.2	6.8	5.9	4.0	3.4
50	9.2	7.3	9.4	6.6	6.2	5.8	3.9	3.4
52	8.5	6.7	9.1	6.0	5.7	5.4	3.8	3.3
54	7.9	6.2	8.5	5.6	5.3	5.0	3.7	3.3
56			7.9	5.2	5.0	4.7	3.6	3.2
58			7.3	4.8	4.9	4.3	3.5	3.2
60			6.7	4.5	4.8	4.1	3.5	3.2
62					4.6	3.9	3.4	3.1
64					4.5	3.7	3.3	3.1
66					4.3		3.3	3.1
68					4.1		3.2	3.1
70							3.2	3.1
72							3.1	3.1
74							3.1	

Table of Fixed Boom Lifting Characteristics (II)

Unit of measurement: t

Length of main boom (m)	50							
	13		19		25		31	
	Jib set angle (°)							
Radius (m)	10	30	10	30	10	30	10	30
16	25							
18	23.7		20.7		11.6			
20	22.7	19.4	18.6		11.3		7.4	
22	21.6	19.0	17.8	13.7	11.2		7.3	
24	20.5	18.3	17	13.5	11.0	7.6	7.1	
26	19.5	17.5	16.2	13.3	10.9	7.4	6.8	
28	18.6	16.8	15.6	13.1	10.8	7.2	6.4	
30	17.9	15.7	15	12.8	10.7	7.0	6.1	4.2
32	17.1	14.8	14.3	12.6	10.6	6.8	5.8	4.0
34	16.3	13.6	14.1	12.2	10.4	6.6	5.5	3.9
36	15.5	12.4	13	11.8	10.0	6.5	5.2	3.9
38	14.4	12.0	12.3	11.4	9.6	6.3	4.9	3.8
40	13.3	11.4	11.5	10.8	9.3	6.1	4.7	3.7
42	12.2	10.6	10.8	9.5	9.0	6.1	4.5	3.6
44	11.4	9.6	9.3	8.5	8.2	6.0	4.3	3.6
46	10.6	8.6	9.8	7.7	7.4	5.9	4.1	3.5
48	9.9	7.8	9.2	7.0	6.7	5.8	4.0	3.4
50	9.2	7.2	8.8	6.4	6.1	5.7	3.9	3.4
52	8.5	6.6	8.4	5.8	5.7	5.3	3.8	3.3
54	7.9	6.1	8	5.4	5.5	4.9	3.7	3.3
56	7.2		7.7	5.1	5.4	4.6	3.6	3.2
58			7.2	4.9	5.2	4.2	3.5	3.2
60			6.6	4.7	5	4.0	3.5	3.2
62			6.2	4.5	4.8	3.8	3.4	3.1
64					4.7	3.6	3.3	3.1
66					4.6	3.5	3.3	3.1
68					4.4	3.4	3.2	3.1
70					3.3		3.2	3.1
72							3.1	3.1
74							3.1	
76							3.0	

Table of Fixed Boom Lifting Characteristics (III)

Unit of measurement: t

Length of main boom (m)	53							
	13		19		25		31	
	Jib set angle (°)							
Length of fly jib (m)								
Radius (m)	Jib set angle (°)							
	10	30	10	30	10	30	10	30
16	24.5							
18	23.7		20.7					
20	22.7	19.0	19.9		11.4		7.3	
22	21.6	18.6	19.5	13.4	10.9		7.2	
24	20.5	18.0	19.1	13.2	10.8		7.0	
26	19.5	17.1	18.8	13.0	10.7	7.2	6.7	
28	18.6	16.4	17.8	12.9	10.6	7.0	6.3	3.7
30	17.9	15.4	16.9	12.6	10.5	6.8	6.0	3.6
32	17.1	14.5	15.9	12.3	10.4	6.7	5.7	3.5
34	16.7	13.3	15	12.0	10.2	6.5	5.4	3.4
36	16	12.2	14.1	11.6	9.8	6.4	5.1	3.3
38	14.5	11.7	13.1	11.1	9.4	6.2	4.8	3.2
40	13.2	11.1	12.7	10.0	9.1	6.0	4.6	3.2
42	12.1	10.4	12.2	9.0	8.8	5.9	4.4	3.1
44	11.2	9.4	11.5	8.3	8.0	5.8	4.2	3.1
46	10.4	8.5	10.7	7.5	7.2	5.7	4.0	3.1
48	9.7	7.7	9.9	6.9	6.6	5.7	3.9	3.0
50	9	7.0	9.3	6.2	6.0	5.6	3.8	3.0
52	8.4	6.4	8.6	5.8	5.8	5.2	3.7	2.9
54	7.7	6.0	8	5.3	5.6	4.8	3.6	2.8
56	7.1	5.6	7.6	5.1	5.3	4.5	3.5	2.8
58	6.6	5.1	7	4.8	5.1	4.1	3.4	2.8
60	6		6.5	4.6	5	3.9	3.4	2.7
62			6	4.4	4.8	3.7	3.3	2.7
64			5.6		4.7	3.6	3.2	2.7
66					4.6	3.4	3.2	2.6
68					4.5	3.3	3.1	2.6
70							3.1	2.6
72							3.0	2.6
74							3.0	2.6
76							2.9	2.6

Table of Fixed Boom Lifting Characteristics (IV)

Unit of measurement: t

Length of main boom (m)	56							
	13		19		25		31	
	Jib set angle (°)							
Length of fly jib (m)								
Radius (m)	Jib set angle (°)							
	10	30	10	30	10	30	10	30
16	25							
18	24.4		20.7					
20	23.2	18.6	19.5		11.5		7.1	
22	22.3	18.2	18.5	13.1	10.7		7.0	
24	21.4	17.6	17.6	13.0	10.5		6.8	
26	20.4	16.8	17	12.8	10.4	7.1	6.5	
28	19.5	16.1	16.1	12.6	10.4	6.9	6.1	
30	18.6	15.1	15.5	12.3	10.3	6.7	5.9	3.5
32	17.9	14.2	14.8	12.1	10.2	6.5	5.6	3.4
34	17	13.0	14.5	11.7	10.0	6.3	5.3	3.3
36	15.8	11.9	13.6	11.4	9.6	6.3	5.0	3.2
38	14.5	11.3	13.2	10.9	9.2	6.1	4.7	3.1
40	13	10.8	12.5	9.8	8.9	5.9	4.5	3.1
42	12.1	10.2	11.7	9.0	8.7	5.8	4.3	3.0
44	11	9.2	11.2	8.1	7.9	5.7	4.1	3.0
46	10.1	7.5	10.5	7.4	7.1	5.6	3.9	3.0
48	9.4	6.9	9.8	6.9	6.4	5.5	3.8	2.9
50	8.7	6.2	9.1	6.2	6.2	5.5	3.7	2.9
52	8.1	5.7	8.4	5.6	5.9	5.1	3.6	2.8
54	7.6	5.3	7.8	5.2	5.8	4.7	3.6	2.7
56	7	5.2	7.3	5.0	5.5	4.4	3.5	2.7
58	6.4	5.0	6.9	4.7	5.4	4.1	3.4	2.7
60	5.8	4.6	6.4	4.5	5.3	3.8	3.4	2.6
62	5.4	4.3	5.5	4.3	5.2	3.7	3.3	2.6
64			5.3	3.9	5.1	3.5	3.2	2.6
66			5	3.6	5	3.4	3.2	2.5
68			4.6	3.3	4.9	3.3	3.1	2.5
70					4.6	3.2	3.1	2.5
72					4.1	3.1	3.0	2.5
74					3.8	3.0	3.0	2.5
76							2.9	2.5
78							2.8	2.6

Table of Fixed Boom Lifting Characteristics (V)

Unit of measurement: t

Length of main boom (m)	59							
	13		19		25		31	
	Jib set angle (°)							
Length of fly jib (m)								
Radius (m)	Jib set angle (°)							
	10	30	10	30	10	30	10	30
16	25							
18	24.4		20.7					
20	23.4	18.3	19.5		11.5		7.0	
22	22.5	17.8	18.5		10.7		6.9	
24	21.4	17.3	17.6	12.7	10.5		6.8	
26	20.4	16.4	17	12.5	10.4	6.9	6.5	
28	19.6	15.8	16.1	12.4	10.4	6.7	6.1	
30	18.8	14.8	15.5	12.1	10.3	6.6	5.8	3.5
32	17.9	13.9	14.8	11.8	10.2	6.4	5.5	3.4
34	17	12.8	14.5	11.5	10.0	6.2	5.2	3.3
36	15.5	11.7	13.6	11.1	9.6	6.1	4.9	3.2
38	14.1	10.7	13.2	10.7	9.2	6.0	4.7	3.1
40	12.9	9.8	12.5	9.6	8.9	5.9	4.5	3.1
42	11.7	9.0	11.7	8.8	8.7	5.7	4.3	3.0
44	11	8.1	11.2	8.0	7.9	5.6	4.1	3.0
46	10.1	7.3	10.5	7.2	7.1	5.5	3.9	3.0
48	9.4	6.6	9.8	6.6	6.4	5.4	3.8	2.9
50	8.7	6.2	9.1	6.2	6.2	5.3	3.7	2.9
52	7.9	5.8	8.4	5.7	5.9	5.0	3.6	2.8
54	7.3	5.5	7.8	5.4	5.8	4.6	3.5	2.7
56	6.7	5.1	7.3	5.1	5.5	4.3	3.4	2.7
58	6.3	4.9	6.3	4.6	5.4	4.0	3.3	2.7
60	5.8	4.6	5.7	4.4	5.3	3.7	3.3	2.6
62	5.3	4.3	5.3	4.2	5.2	3.6	3.2	2.6
64	4.9	4.1	4.9	4.1	5.1	3.4	3.1	2.6
66			4.7	3.8	4.9	3.3	3.1	2.5
68			4.3	3.4	4.5	3.2	3.0	2.5
70			3.9	3.2	4.4	3.1	3.0	2.5
72					4.1	3.0	2.9	2.5
74					3.8	2.9	2.9	2.5
76					3.3	2.8	2.9	2.5
78							2.6	2.5

Table of Fixed Boom Lifting Characteristics (VI)

Unit of measurement: t

Length of main boom (m)	62							
	13		19		25		31	
	Jib set angle (°)							
Length of fly jib (m)								
Radius (m)	Jib set angle (°)							
	10	30	10	30	10	30	10	30
16	25							
18	24.6		20.7					
20	23.7	18.1	19.5		11.5		7.0	
22	22.9	17.7	18.5	12.8	10.7		6.9	
24	21.8	17.1	17.6	12.6	10.5		6.7	
26	20.9	16.3	17	12.4	10.4		6.4	
28	20.1	15.6	16.1	12.2	10.4	6.9	6.0	
30	19	14.6	15.5	12.0	10.3	6.7	5.7	3.5
32	18.2	13.8	14.8	11.7	10.2	6.5	5.5	3.4
34	17	12.7	14.5	11.4	10.0	6.3	5.2	3.3
36	15.3	11.6	13.6	11.0	9.6	6.2	4.9	3.2
38	13.7	10.6	13.2	10.5	9.2	6.1	4.6	3.1
40	12.6	9.7	12.5	9.6	8.9	6.0	4.4	3.1
42	11.4	8.9	11.7	8.8	8.7	5.9	4.2	3.0
44	10.5	8.1	11.2	8.0	7.9	5.8	4.0	3.0
46	9.7	7.3	10.5	7.3	7.1	5.7	3.9	3.0
48	9	6.7	9.8	6.7	6.4	5.6	3.8	2.9
50	8.2	6.2	9.1	6.2	6.2	5.4	3.7	2.9
52	7.6	5.8	8.4	5.8	5.9	5.3	3.6	2.8
54	6.9	5.4	7.8	5.4	5.8	5.2	3.5	2.7
56	6.4	5.0	7.3	5.0	5.5	5.1	3.4	2.7
58	5.9	4.8	6.3	4.6	5.4	4.3	3.3	2.7
60	5.4	4.6	5.7	4.3	5.3	3.9	3.3	2.6
62	4.9	4.3	5.3	4.2	5.2	3.7	3.2	2.6
64	4.5	4.1	4.9	4.1	5.1	3.6	3.1	2.6
66	4	3.9	4.7	3.8	4.7	3.4	3.1	2.5
68			4.3	3.3	4.3	3.3	3.0	2.5
70			3.9	3.0	4	3.2	3.0	2.5
72			3.3	2.9	3.7	3.1	2.9	2.5
74					3.4	3.0	2.9	2.5
76					3.1	2.9	2.8	2.5
78					2.8	2.8	2.3	2.3
80							2.0	2.0

Table of Fixed Boom Lifting Characteristics (VII)

Unit of measurement: t

Length of main boom (m)	65							
	13		19		25		31	
	Jib set angle (°)							
Length of fly jib (m)								
Radius (m)	Jib set angle (°)							
	10	30	10	30	10	30	10	30
18	25							
20	23.7		20.5		11.5		6.9	
22	22.9	17.5	18.5		11.1		6.8	
24	21.8	16.9	18.1	12.5	10.9		6.6	
26	20.9	16.1	17.3	12.3	10.6	6.8	6.3	
28	20.1	15.5	16.5	12.1	10.4	6.6	6.0	
30	19	14.5	16.1	11.9	9.9	6.4	5.7	3.4
32	18.2	13.7	15.2	11.6	9.5	6.3	5.4	3.3
34	17	12.5	14.5	11.3	9.1	6.1	5.1	3.2
36	15.3	11.5	14.1	10.9	8.7	6.0	4.8	3.1
38	13.7	10.5	13.4	10.5	8.5	6.0	4.6	3.0
40	12.3	9.6	12.7	9.5	8.1	6.0	4.4	3.0
42	11.2	8.8	11.7	8.7	7.7	5.9	4.2	3.0
44	10.3	8.0	10.7	7.8	7.5	5.7	4.0	3.0
46	9.4	7.2	9.8	7.0	7.1	5.6	3.8	2.9
48	8.7	6.5	9.1	6.4	6.7	5.4	3.7	2.9
50	8	5.9	8.4	6.2	6.4	5.3	3.6	2.9
52	7.3	5.7	7.6	5.6	6.1	5.1	3.5	2.8
54	6.7	5.4	7	5.3	5.8	5.0	3.4	2.8
56	6.1	5.0	6.5	5.0	5.5	4.5	3.4	2.7
58	5.7	4.8	5.8	4.6	5.4	3.9	3.3	2.7
60	5.2	4.6	5.4	4.3	5.3	3.7	3.3	2.6
62	4.8	4.3	4.9	4.1	5.2	3.5	3.2	2.6
64	4.3	4.1	4.7	4.1	5.1	3.3	3.1	2.6
66	3.9	3.9	4.3	3.6	4.4	3.2	3.1	2.5
68	3.3	3.6	3.9	3.3	4.2	3.1	3.0	2.5
70			3.6	3.0	3.9	3.0	3.0	2.5
72			3.2	2.9	3.5	2.9	2.9	2.5
74			3	2.8	3.2	2.8	2.8	2.5
76			2.7		3		2.6	2.5
78					2.6		2.4	2.3
80							2.1	2.0

Table of Fixed Boom Lifting Characteristics (VIII)

Unit of measurement: t

Length of main boom (m)	68							
	13		19		25		31	
	Jib set angle (°)							
Length of fly jib (m)								
Radius (m)	Jib set angle (°)							
	10	30	10	30	10	30	10	30
18	25							
20	24.1	17.5	20.5					
22	22.9	17.3	18.9		11.4			
24	22.1	16.8	18.5	12.3	11.4			
26	21.3	15.9	18.1	12.2	10.6	6.7	6.3	
28	20.3	15.3	16.5	12.0	10.4	6.5	5.9	
30	19.6	14.3	16.1	11.7	9.9	6.4	5.6	3.5
32	17.9	13.5	15.6	11.5	9.5	6.2	5.4	3.4
34	16.6	12.4	15	11.1	9.1	6.0	5.1	3.3
36	15.2	11.4	14.9	10.8	8.7	6.0	4.8	3.2
38	13.9	10.4	13.5	10.4	8.5	6.0	4.5	3.1
40	12.3	9.5	12.6	9.3	8.1	6.0	4.3	3.0
42	11.2	8.7	11.7	8.6	7.7	5.9	4.2	3.0
44	10.2	7.9	10.6	7.6	7.5	5.7	4.0	3.0
46	9.3	7.1	9.6	7.0	7.1	5.6	3.8	3.0
48	8.5	6.4	8.8	6.4	6.7	5.4	3.7	3.0
50	7.9	5.9	7.9	5.9	6.4	5.3	3.6	2.9
52	7.2	5.6	7.1	5.5	6.1	5.1	3.5	2.8
54	6.6	5.3	6.6	5.3	5.8	5.0	3.4	2.8
56	6	4.9	6.1	4.9	5.5	4.5	3.3	2.7
58	5.6	4.6	5.6	4.5	5.4	4.1	3.2	2.6
60	5.1	4.5	5	4.3	5.3	3.6	3.2	2.6
62	4.6	4.4	4.6	4.1	5.2	3.5	3.1	2.5
64	4.3	4.1	4.3	3.6	5.1	3.3	3.0	2.5
66	3.9	3.9	3.9	3.3	4.4	3.2	3.0	2.5
68	3.4	3.7	3.5	2.9	4.2	2.9	2.9	2.4
70	3.2	3.4	3.3	2.6	3.8	2.6	2.6	2.4
72	2.9	3.1	3.1	2.3	3.5	2.3	2.3	2.3
74			3	2.0	3.1	2.0	2.2	2.0
76					2.8		2.1	
78					2.6		2	
80							1.9	

Table of Fixed Boom Lifting Characteristics (IX)

Unit of measurement: t

Length of main boom (m)	71							
	13		19		25		31	
	Jib set angle (°)							
Length of fly jib (m)	10		30		10		30	
Radius (m)	10	30	10	30	10	30	10	30
18	25							
20	24.1		20.5					
22	23.5	17.0	19.1		11.4			
24	22.8	16.4	18.5	12.2	11.4			
26	22	15.6	18.1	12.0	10.6	6.6	6.2	
28	20.9	15.0	16.5	11.9	10.4	6.5	5.8	
30	19.6	14.1	16.1	11.6	9.9	6.3	5.6	
32	17.9	13.3	15.6	11.4	9.5	6.1	5.3	3.3
34	16.2	12.2	15	11.0	9.1	6.0	5.0	3.2
36	14.7	11.1	14.9	10.7	8.7	6.0	4.7	3.1
38	13.6	10.2	13.5	10.3	8.5	6.0	4.5	3.0
40	12.3	9.4	12.6	9.0	8.1	6.0	4.3	3.0
42	11.2	8.6	11.7	8.1	7.7	6.0	4.1	3.0
44	10.2	7.8	10.6	7.5	7.5	5.8	4.0	3.0
46	9.3	7.0	9.6	6.9	7.1	5.6	3.9	3.0
48	8.5	6.4	8.8	6.4	6.7	5.4	3.8	3.0
50	7.9	5.9	7.9	5.9	6.4	5.2	3.7	2.9
52	7.2	5.6	7.1	5.6	6.1	5.0	3.6	2.8
54	6.6	5.2	6.6	5.2	5.8	4.8	3.4	2.8
56	6	4.8	6.1	4.7	5.5	4.4	3.3	2.7
58	5.6	4.5	5.6	4.4	5.4	4.0	3.2	2.6
60	5.1	4.4	5	4.2	5.3	3.6	3.2	2.5
62	4.4	4.3	4.6	3.8	5.1	3.4	3.1	2.5
64	4.1	4.0	4.3	3.4	4.7	3.3	3.0	2.5
66	3.6	3.8	3.9	3.0	4.3	3.2	3.0	2.4
68	3.2	3.5	3.5	2.7	4.1	2.9	2.9	2.4
70	3.1	3.2	3.3	2.4	3.7	2.6	2.6	2.3
72	2.6	2.9	3.1	2.3	3.3	2.3	2.3	2.3
74	2.5	2.6	3	2.0	2.9	2.0	2.1	2.0
76			2.3		2.5		2	
78			2		2.3		1.9	
80							1.8	

Notes:

1. The actual lifting capacity is equal to the rated lifting capacity values listed in the table minus the weights of all slings, including the lifting hook, etc;
2. The rated lifting capacity as shown in the diagram is equal to the value of the load being lifted on a level, firm surface;
3. During crane operations with the fixed fly jib, simultaneous working of the main boom and fixed fly jib is prohibited.

13. Lifting Characteristics of Main Boom + Luffing Fly Jib

Luffing Fly Jib Lifting Height Curve

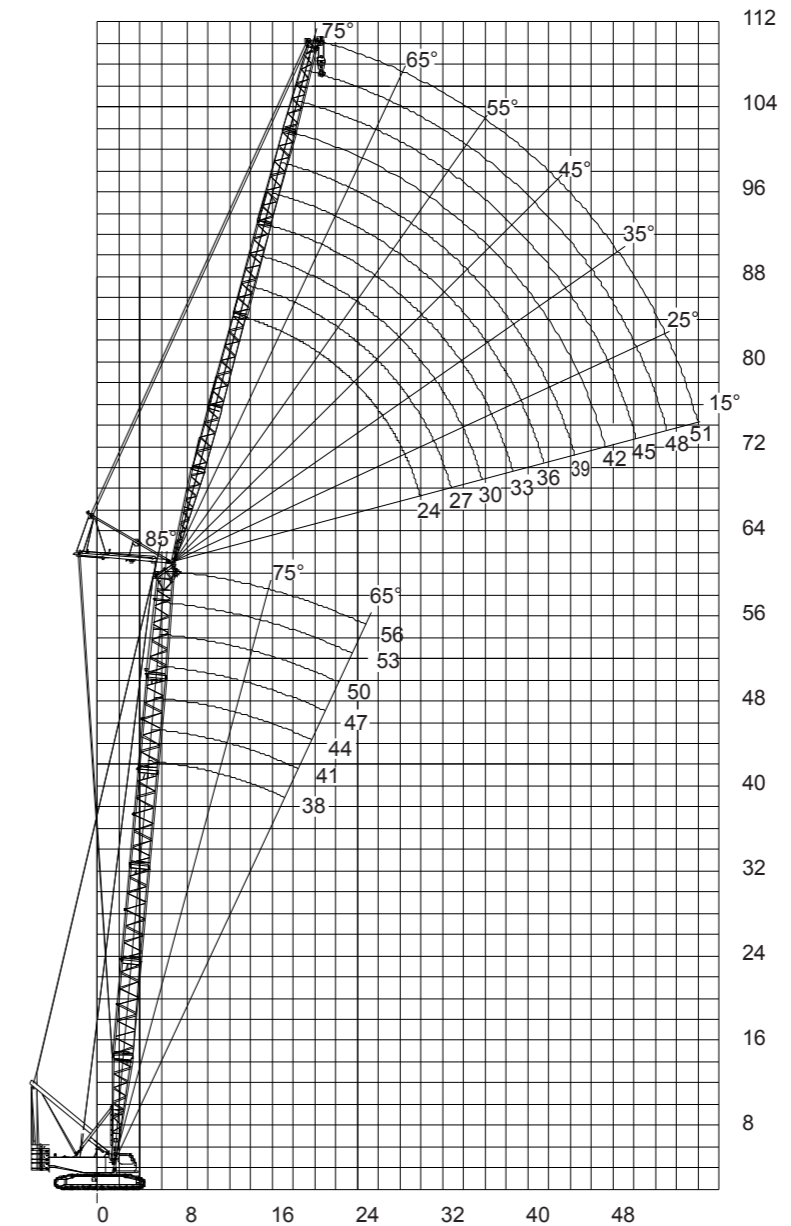

Notes:

1. The working radius is shown along the horizontal axis, the lifting height is shown along the vertical axis, and unit of measurement is meter (unit: m).
2. The working length of the main boom during crane operations with luffing fly jib is 38~56m, and the working length of the luffing fly jib is 24~51m.

Table of Luffing Fly Jib Lifting Performance (I)

Unit of measurement: t

Length of main boom (m)	38											
	24			27			30			33		
Length of fly jib (m)	Working angle of main boom (°)											
Radius (m)	85	75	65	85	75	65	85	75	65	85	75	65
12	38.3											
14	35.5			32.3			29.2					
16	30.5			28.9			27.5			24.9		
18	27.5			26.1			24.8			23.7		
20	25.0			23.7			21.2			20.3		
22	20.0			19.5			19.2			18.5		
24	17.8	23.2		17.5	22.8		17.1			16.9		
26	16.1	21.3		15.7	20.9		15.5	20.8		15.2		
28	14.5	19.6		14.2	18.7		13.9	18.3		13.7	17.5	
30		16.9		13.0	16.6		12.7	16.3		12.5	16.0	
32		15.3	16/33		14.9		11.6	14.7		11.5	14.4	
34		13.8	15		13.5	14.6	9.0	13.3		8.8	13.0	
36			14.5		12.3	13.6		12.1	13.4	8.3	11.8	
38			14			12.8		11.0	12.6		10.8	12.4
40			13			12.0		8.4	11.8		8.3	11.8
42						11.3			11.2		7.8	11.2
44						10.7			10.7			10.5
46									8.6			8.4
48												7.8

Table of Luffing Fly Jib Lifting Performance (II)

Unit of measurement: t

Length of main boom (m)	38											
	36			39			42			45		
Length of fly jib (m)	Working angle of main boom (°)											
Radius (m)	85	75	65	85	75	65	85	75	65	85	75	65
16	21.3			18.9								
18	20.6			18.4			16.3			14.0		
20	19.4			17.6			15.7			13.6		
22	17.6			17.0			15.2			13.3		
24	16.3			15.5			14.6			12.9		
26	14.9			14.2			13.5			12.5		
28	13.5	16.7		13.2			12.5			11.9		
30	12.4	15.3		12.1	14.7		11.5	13.6		9.6		
32	9.4	14.1		9.2	13.4		9.1	12.8		9.0	11.6	
34	8.6	12.8		8.5	12.3		8.5	11.8		8.3	11.2	
36	8.1	11.7		7.9	11.4		7.7	10.8		7.6	9.1	
38	7.5	10.6		7.4	10.4		7.2	8.6		7.0	8.4	
40		8.2	11.7	6.8	8.1		6.6	7.9		6.5	7.8	
42		7.6	11.0	6.3	7.4	9.3	6.3	7.3		6.1	7.2	
44		7.1	10.3		6.9	9.3	5.9	6.8	8.7	5.7	6.6	
46		6.6	8.3		6.4	8.1		6.3	8.0	5.5	6.1	7.9
48			7.7		5.9	7.6		5.8	7.4	5.1	5.7	7.3
50			7.1			7.0		5.4	6.8		5.3	6.8
52			6.6			6.5		5.3	6.4		5.1	6.3
54						6.1			5.9		4.8	5.8
56									5.6			5.4
58									5.3			5.2
60												4.8

Table of Luffing Fly Jib Lifting Performance (III)

Unit of measurement: t

Length of main boom (m)	38					
	48			51		
Length of fly jib (m)	Working angle of main boom (°)					
Radius (m)	85	75	65	85	75	65
	18	10.1				
20	10.1			8.4		
22	9.7			8.2		
24	9.5			7.9		
26	9.4			7.7		
28	9.2			7.5		
30	9.0			7.4		
32	8.5			7.2		
34	7.8	8.4		7.0	7.0	
36	7.2	8.3		6.7	6.8	
38	6.6	8.0		6.1	6.7	
40	6.1	7.3		5.7	6.4	
42	5.7	6.8		5.5	6.3	
44	5.5	6.3		5.1	5.8	
46	5.1	5.8	7.4	4.7	5.4	
48	4.7	5.3	6.8	4.4	5.1	6.3
50	4.5	5.0	6.3	4.2	4.8	5.9
52		4.8	5.8	3.8	4.4	5.4
54		4.5	5.4	3.6	4.2	5.2
56		4.2	5.2		3.8	4.8
58		4.0	4.8		3.7	4.5
60			4.5		3.3	4.2
62			4.3			3.9
64			4.0			3.7
66						3.4

Table of Luffing Fly Jib Lifting Performance (IV)

Unit of measurement: t

Length of main boom (m)	47											
	24			27			30			33		
Length of fly jib (m)	Working angle of main boom (°)											
Radius (m)	85	75	65	85	75	65	85	75	65	85	75	65
	14	37.3			34.3							
16	31.8			30.2			28.5			25.3		
18	28.5			27.2			25.7			24.4		
20	25.9			24.6			23.4			20.9		
22	23.4			20.5			20.1			19.2		
24	18.6			18.3			17.9			17.5		
26	16.7	19.9		16.4	19.6		16.1			15.8		
28	15.1	18.5		14.8	18.2		14.5	18.0		14.3		
30		17.2		13.4	16.8		13.3	16.7		13.0	16.3	
32		16.0			15.8		12.1	15.6		11.8	15.4	
34		15.1			14.9		9.3	14.6		9.2	14.4	
36		13.9	12.6		13.7			13.4		8.5	13.2	
38			12.0		12.4	11.7		12.2			12.0	
40			11.3		11.3	11.0		11.2	10.8		11.0	
42			10.7			10.5		8.6	10.3		8.4	10.0
44			10.0			9.8			9.8		7.8	9.5
46						9.3			9.3			9.2
48									8.8			8.7
50									8.4			8.3
52												7.8
54												7.4/53

Table of Luffing Fly Jib Lifting Performance (V)

Unit of measurement: t

Length of main boom (m)	47											
	36			39			42			45		
Length of fly jib (m)	Working angle of main boom (°)											
Radius (m)	85	75	65	85	75	65	85	75	65	85	75	65
	16	22.5										
18	20.8			18.5			16.5			14.2		
20	20.1			17.9			15.9			13.8		
22	18.3			17.3			15.4			13.4		
24	16.8			16.1			14.8			13.1		
26	15.5			14.7			14.0			12.7		
28	14.0			13.5			12.9			12.2		
30	12.7	16.2		12.5			11.9			11.3		
32	11.6	15.1		11.5	14.8		9.4			9.2		
34	9.0	14.1		8.8	13.6		8.6	13.0		8.5	11.7	
36	8.3	13.0		8.1	12.5		8.0	12.0		7.9	11.3	
38	7.7	11.8		7.5	11.6		7.4	11.0		7.3	10.4	
40	7.2	10.8		7.0	10.6		6.8	8.7		6.7	8.6	
42		8.3		6.5	8.1		6.5	8.0		6.2	7.9	
44		7.7	9.3		7.6		6.0	7.4		5.8	7.3	
46		7.1	8.8		7.0	8.7	5.7	6.8		5.6	6.8	
48		6.6	8.6		6.5	8.4		6.3	8.1	5.3	6.3	
50			8.3		6.1	7.9		5.9	7.8		5.8	7.6
52			7.6			7.4		5.6	7.3		5.4	7.3
54			7.1			6.9		5.3	6.8		5.2	6.7
56			6.6			6.4			6.3		4.8	6.2
58						6.0			5.9			5.7
60									5.5			5.3
62									5.3			5.2
64												4.8

Table of Luffing Fly Jib Lifting Performance (VI)

Unit of measurement: t

Length of main boom (m)	47					
	48			51		
Length of fly jib (m)	Working angle of main boom (°)					
Radius (m)	85	75	65	85	75	65
	20	10.1			8.5	
22	9.8			8.3		
24	9.6			8.1		
26	9.5			7.8		
28	9.2			7.6		
30	9.0			7.5		
32	8.8			7.3		
34	8.1			7.1		
36	7.4	8.5		6.8		
38	6.8	8.3		6.4	6.8	
40	6.3	8.1		5.9	6.7	
42	5.8	7.4		5.6	6.5	
44	5.5	6.8		5.2	6.3	
46	5.3	6.3		4.9	5.9	
48	4.9	5.8		4.5	5.4	
50	4.5	5.4	7.4	4.2	5.2	
52	4.4	5.2	6.8	4.0	4.8	6.3
54		4.8	6.3	3.7	4.5	5.8
56		4.5	5.8		4.2	5.4
58		4.3	5.3		3.9	5.2
60		4.0	5.1		3.7	4.8
62			4.8		3.4	4.5
64			4.5			4.2
66			4.2			3.8
68			4.0			3.7
70						3.4

Table of Luffing Fly Jib Lifting Performance (VII)

Unit of measurement: t

Length of main boom (m)	56											
	24			27			30			33		
Length of fly jib (m)	Working angle of main boom (°)											
Radius (m)	85	75	65	85	75	65	85	75	65	85	75	65
14	32.6											
16	30.0			29.8			28.9			25.7		
18	27.7			27.5			26.9			24.7		
20	25.7			25.5			24.4			23.2		
22	24.0			23.3			20.8			19.9		
24	19.5			19.1			18.7			18.2		
26	17.4			17.1			16.8			16.5		
28	15.7	17.5		15.4			15.1			14.8		
30		16.3		13.9	16.2		13.6	15.8		13.4		
32		15.3		12.7	15.1		12.5	14.9		12.3	14.6	
34		14.3			14.1		11.5	13.9		9.4	13.8	
36		13.4			13.3			13.1		8.7	12.9	
38		12.8			12.6			12.3		8.1	12.2	
40			10.2		12.0			11.7			11.5	
42			9.7		11.2	9.5		11.2			11.0	
44			9.2			9.0		8.7	8.8		8.6	
46			8.7			8.6			8.4		7.9	
48			8.3			8.1			7.9		7.3	8.3
50						7.8			7.6			7.9
52									7.1			7.4
54										6.8		6.9
56												6.6

Table of Luffing Fly Jib Lifting Performance (VIII)

Unit of measurement: t

Length of main boom (m)	56											
	36			39			42			45		
Length of fly jib (m)	Working angle of main boom (°)											
Radius (m)	85	75	65	85	75	65	85	75	65	85	75	65
18	21.2			18.8			16.7					
20	20.5			18.2			16.2			13.9		
22	19.0			17.5			15.5			13.5		
24	17.4			16.6			15.1			13.3		
26	16.0			15.2			14.5			12.9		
28	14.5			14.0			13.3			12.4		
30	13.3			12.9			12.3			11.6		
32	12.1			11.8			9.6			9.5		
34	9.2	13.4		9.1	13.3		8.9			8.8		
36	8.5	12.6		8.5	12.4		8.3	12.3		8.1	11.8	
38	7.9	12.0		7.7	11.8		7.6	11.7		7.5	11.3	
40	7.4	11.3		7.2	11.2		7.1	11.0		6.9	10.6	
42		10.7		6.7	10.5		6.6	8.7		6.5	8.7	
44		8.4		6.3	8.3		6.1	8.1		5.9	7.9	
46		7.8			7.6		5.8	7.5		5.6	7.3	
48		7.3	7.6		7.1			6.9		5.4	6.8	
50		6.8	7.3		6.6	6.9		6.4		5.1	6.3	
52			6.8		6.1	6.6		5.9	6.4		5.8	6.3
54			6.4		5.7	6.3		5.6	6.1		5.4	5.8
56			6.1			5.9		5.3	5.6		5.2	5.6
58			5.8			5.6			5.4		4.8	5.3
60			5.4			5.3			5.3			5.2
62						5.2				5.0		4.8
64										4.8		4.7
66										4.7		4.5
68												4.3

Table of Luffing Fly Jib Lifting Performance (IX)

Unit of measurement: t

Length of main boom (m)	56					
	48			51		
Length of fly jib (m)	Working angle of main boom (°)					
	85	75	65	85	75	65
20	10.1					
22	10.1			8.4		
24	9.7			8.1		
26	9.5			7.9		
28	9.4			7.7		
30	9.1			7.5		
32	9.0			7.4		
34	8.3			7.2		
36	7.6			7.0		
38	7.0	8.5		6.6		
40	6.5	8.3		6.1	6.9	
42	6.0	8.2		5.7	6.8	
44	5.6	7.6		5.3	6.5	
46	5.3	6.9		5.0	6.3	
48	5.0	6.4		4.6	5.9	
50	4.7	5.8		4.4	5.5	
52	4.4	5.4		4.0	5.2	
54		5.2	5.6	3.8	4.8	
56		4.8	5.4		4.5	5.3
58		4.5	5.2		4.2	5.0
60		4.3	5.0		4.0	4.8
62		4.0	4.8		3.7	4.7
64			4.5		3.5	4.5
66			4.3			4.2
68			4.2			4.0
70			4.0			3.8
72			3.8			3.7
74						3.3

Notes:

1. The actual lifting capacity is equal to the rated lifting capacity values listed in the table minus the weights of all slings, including the lifting hook, etc;
2. The rated lifting capacity as shown in the diagram is equal to the value of the load being lifted on a level, firm surface;