











TOPKIT MD 265







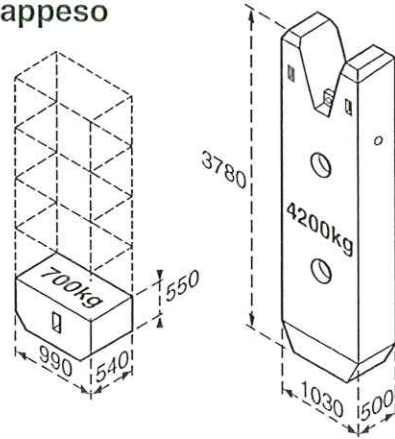

















Lest de contre-flèche - Gegenauslegerballast - Counter-jib ballast
Lastre de contra flecha - Contrappeso

			(t)
65m	18m		18 900 = (4x4200)+(3x700)
60m	18m		18 200 = (4x4200)+(2x700)
55m	18m		15 400 = (3x4200)+(4x700)
50m	18m		12 600 = (3x4200)
45m	12m		24 500 = (5x4200)+(5x700)
40m	12m		22 400 = (5x4200)+(2x700)
35m	12m		19 600 = (4x4200)+(4x700)
30m	12m		15 400 = (3x4200)+(4x700)
25m	12m		13 300 = (3x4200)+(1x700)



Lest de base - Grundballast - Base ballast - Lastre de base - Zavorra di base

H(m)		(t)	H(m)		(t)
69,6		108			
66,3		96			
61,3		72			
56,3		48	50,9		75
51,3		36	47,6		75
46,3		36	42,6		75
41,3		36	37,6		75
36,3		36	32,6		75
31,3		36	27,6		75
26,3		36	22,6		75
21,3		36	17,6		75
16,3		36	12,6		75
V 60 A ◀●▶			ZD 46 A ◀●▶		
□ 2m					

ZD
46
A

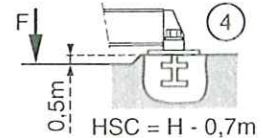
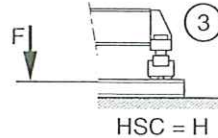
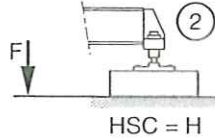
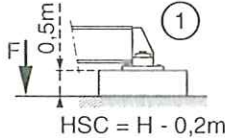

Télescopage sur dalles - Kletterkrane im Gebäude - Climbing crane
Telescopage gruas trepadoras - Gru in cavedio

B 60 A

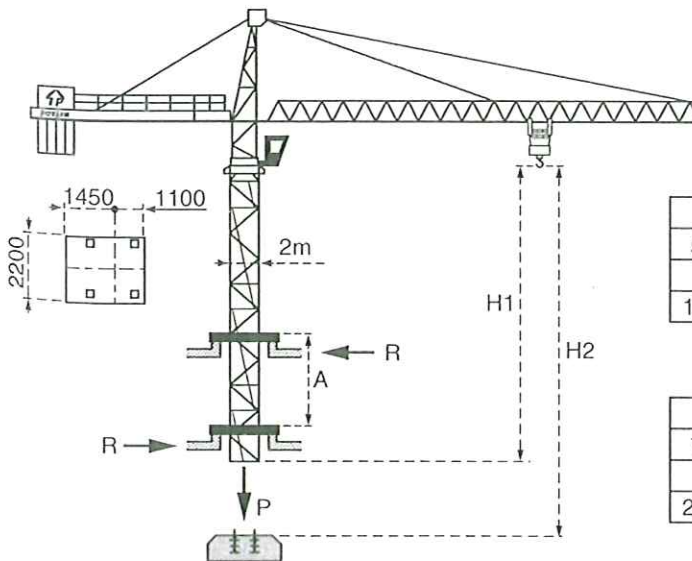

H2	
55 RCS 30D	
185 m	92 m

H2	
70 RCS 30D	
230 m	115 m

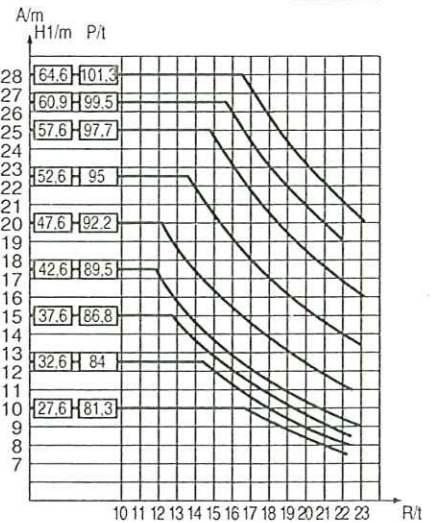

- | | | | | |
|---------------------------------|-------------------------------|-----------------------------|---------------------------------|--------------------------------|
| A Distance entre cadres | A Abstand zwischen den Rahmen | A Distance between collars | A Distancia entre marcos | A Distanza fra i telai |
| H1 Hauteur grue | H1 Kranhöhe | H1 Crane height | H1 Altura grúa | H1 Altezza gru |
| P Poids de la grue (en service) | P Krangewicht (in Betrieb) | P Crane weight (in service) | P Peso de la grúa (en servicio) | P Peso della gru (in servizio) |
| R Réaction horizontale | R Horizontalkräfte | R Horizontal reaction | R Reaccion horizontal | R Reazione orizzontale |

Mats - Maste - Masts - Mástil - Torre

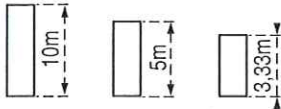

□ 2 m
MD 265 J12

Flèche - Ausleger - Jib
Flecha - Braccio
25m ⇒ 65m

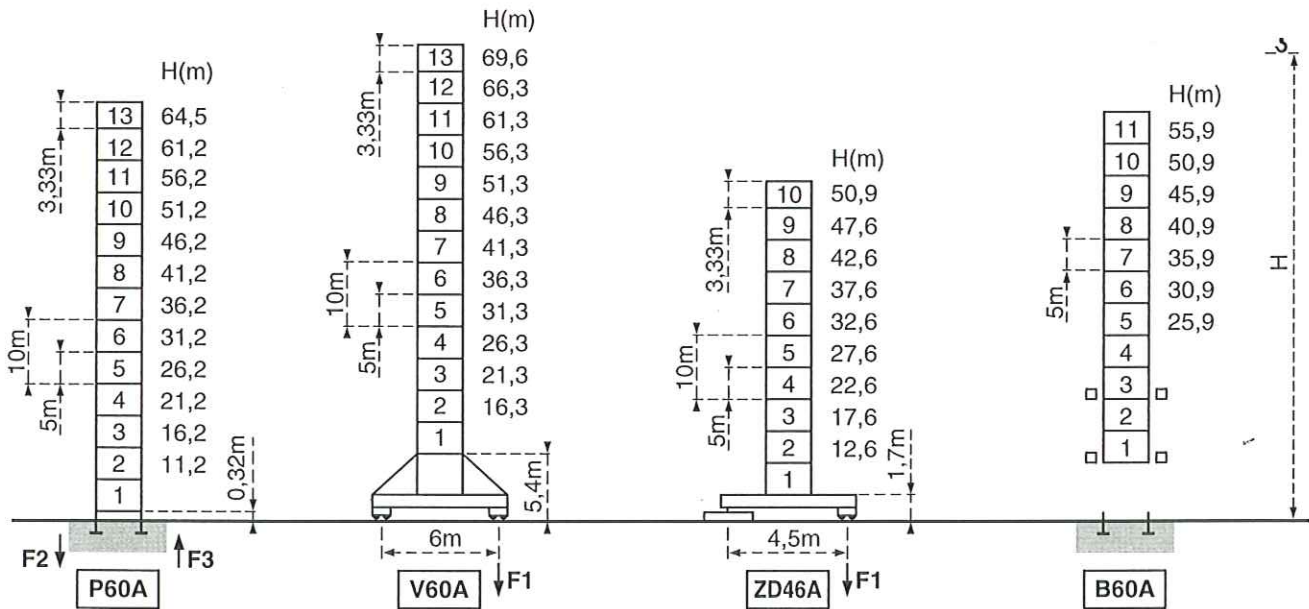



F2	● 158t	■ 216t
F3	● 106t	■ 170t

F1	● 105t	■ 141t
----	--------	--------

F1	● 93t	■ 98t
----	-------	-------

	73t
---	-----

	86t
---	-----

	78t
---	-----

Nous consulter
Auf Anfrage
Consult us
Consultarnos
Consultateci

F = Réactions - Eckdrücke - Reactions - Reacciones - Reazioni

Flèche
Ausleger
Jib
Flecha
Braccio

Courbes de charges - Lastkurven - Load diagrams - Curvas de cargas - Curve di carico

	16,5	20	22	25	27	29,1	32,1	35	37	40	42	45	47	50	52	55	57	60	62	65	m	
65m	12	9,6	8,5	7,3	6,6	6	6	5,4	5,1	4,6	4,4	4	3,8	3,5	3,3	3,1	2,97	2,78	2,66	2,5	t	
60m	12	11,2	10	8,6	7,8	6,8	6	6	5,9	5,4	5,1	4,7	4,5	4,1	3,9	3,7	3,5	3,3				m
55m	12	11,5	10,3	8,8	8	7,1	6,5	6	6	5,6	5,3	4,8	4,6	4,3	4,1	3,8						t
50m	12	11,6	10,3	8,9	8,1	7,1	6,5	6	6	5,6	5,3	4,9	4,6	4,3								m
45m	12	11,6	10,3	8,9	8,1	7,1	6,5	6	6	5,6	5,3	4,9										t
40m	12	11,6	10,3	8,9	8,1	7,1	6,5	6	6	5,6												m
35m	12	11,7	10,4	9	8,2	7,2	6,6	5,9														t
30m	12	11,8	10,5	9	8,2	7,2																m
25m	12	11,8	10,5	9																		t

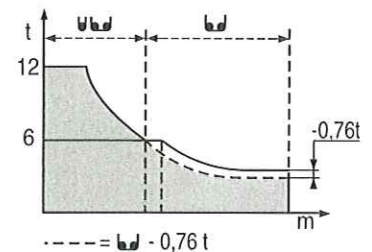

Ancrages - Verankerungen - Anchorages - Anclaje - Ancoraggio

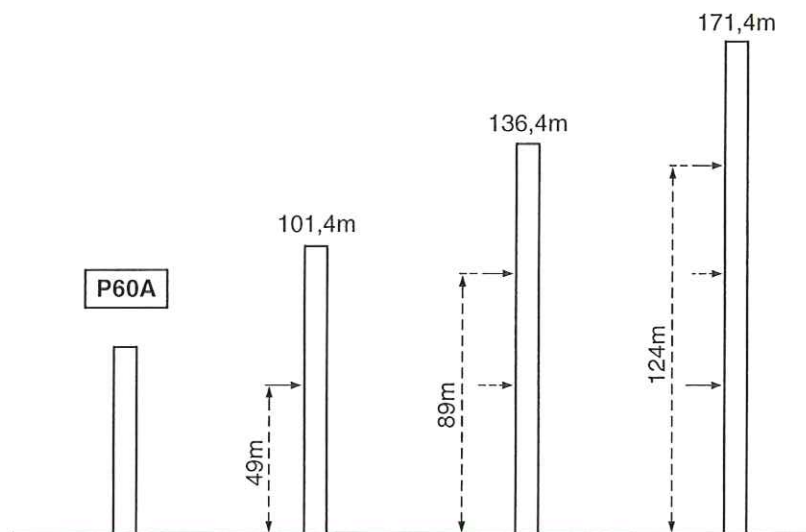

■ En service
● Hors service

■ In Betrieb
● Ausser Betrieb

■ In service
● Out of service

■ En servicio
● Fuera de servicio

■ In servizio
● Fuori servizio

⊕ A vide sans lest
avec flèche et hauteur
maximum.

⊕ Ohne Last und Ballast
mit Maximalausleger und
Maximalhöhe.

⊕ Without load and
ballast with longest jib
and maximum height.

⊕ Sin carga, sin
lastre con flecha y
altura máximas.

⊕ A vuoto senza zavorra
e con braccio massimo e
altezza massima.

